

Operating Instructions

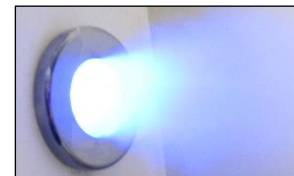

Brine fogging system Type SOLFOG V3



WDT - Werner Dosiertechnik GmbH & Co. KG,
Hettlinger Str. 17, D-86637 Wertingen-Geratshofen, Germany
Phone: +49 82 72 / 9 86 97 – 0, Fax: +49 82 72 / 9 86 97 – 19
www.werner-dosiertechnik.de, info@werner-dosiertechnik.de

(Original installation and operating instructions)

Preface

Dear customer,

Thank you for choosing WDT's brine fogging system.

The brine fog maker SOLFOG V3 corresponds to the latest state of the art.

Please contact us if you have any further questions. For queries and spare parts orders, please always have the device type and serial number (see identification plate on the device) at hand!

Reproduction of any kind and translation into other languages, even in excerpts, is only permitted with the express authorisation of the company WDT - Werner Dosiertechnik GmbH & Co. KG.

All rights and technical modifications reserved.

© Copyright WDT – Werner Dosiertechnik GmbH & Co KG (Edition: see footer)

Manufacturer and contact

WDT - Werner Dosiertechnik GmbH & Co. KG

Hettlinger Str. 17

D-86637 Wertingen-Geratshofen, Germany

Phone: +49 8272 / 98697 – 0 (Switchboard)

Phone: +49 8272 / 98697 – 380 (Technical Hotline)

Fax: +49 8272 / 98697 - 19

Email: info@werner-dosiertechnik.de – Web: www.werner-dosiertechnik.de

Table of contents

1	About these instructions / general	5
1.1	Scope of applicability	5
1.2	Target group.....	5
1.3	Symbols used	5
1.4	Further means of representation.....	7
1.5	Warranty	7
1.5.1	General terms and conditions of warranty.....	7
1.6	Additional information.....	8
1.7	Information regarding support queries/ identification plate	8
2	Safety notices	9
2.1	Intended use	9
2.2	Personnel	9
2.3	Electrical system.....	10
2.4	Operation of the device	10
3	Scope of delivery / accessories / functional description	12
3.1	Scope of delivery / accessories	12
3.2	Structure of the overall system.....	12
3.3	Functional description.....	13
3.4	Description of components.....	13
3.4.1	Control unit	13
3.4.2	Brine dosing	13
3.4.3	Ultrasonic fog maker	14
3.4.4	Dosing unit for the scenting	14
3.4.5	Button plate (option)	14
3.4.6	Lighting system for fog outlet (option)	15
3.5	Technical data	15
4	Transport and storage	16
4.1	General safety notices	16
4.2	Packaging	16
4.3	Temporary storage of the device.....	16
4.4	Storage of fragrance oil concentrates / brine.....	16
5	Mechanical installation	17
5.1	General safety notices	17
5.2	Select the installation site.....	17
5.3	Installation notices.....	17
5.4	Install SOLFOG V3.....	18
5.5	Fog maker pipe connection.....	18
5.5.1	Install the piping.....	18
6	Electrical installation	22
6.1	Safety notices.....	22
6.2	Electrical connection.....	22
6.3	Additional connection options.....	22
7	Commissioning	23
7.1	General safety notices	23
7.2	General remarks.....	23
7.3	Commissioning steps.....	23
7.4	Display and controls.....	24
7.5	Insert the roller carrier at the fragrance pump.....	24
7.6	Disassembling the roller carrier	26
7.7	Switching on the device	26
7.7.1	Start query / initial start of the device.....	26
7.7.2	Reactivating the device	27
7.8	Carry out disinfection with politainer change.....	27
7.8.1	General information regarding disinfection	27
7.8.2	Disinfection procedure.....	28

7.9	Inserting/changing the brine politainer	33
8	Operation / Use.....	34
8.1	General safety notices.....	34
8.2	Check for operational readiness.....	35
8.3	Operation	35
8.4	Switching on / off	35
8.5	Button plate function	36
8.6	Fog lighting function.....	36
8.7	Control unit	37
8.7.1	Operation display	38
8.7.2	Start disinfection	39
8.7.3	Set pause time.....	39
8.7.4	Set fogging time.....	39
8.7.5	Set operation modes	40
8.7.6	Set push button cycle	40
8.7.7	Set fan rotation speed	41
8.7.8	Check electrical outputs	41
8.7.9	Check electrical inputs.....	42
8.7.10	Set language	42
8.7.11	Set Time/date	43
8.7.12	Time switch / set switch times	43
8.7.13	Set contrast	45
8.7.14	Display device information.....	45
8.7.15	Display data log	45
8.7.16	Conduct a reset	46
8.7.17	Config / set password protection	46
8.7.18	Set Config / Push button illumination	47
8.8	Change the brine solution	48
8.9	Replenish fragrance oil concentrate	48
9	Maintenance / Fault removal.....	50
9.1	Open/close the control housing.....	50
9.2	Device maintenance.....	51
9.3	Check/change hose bracket kit	52
9.3.1	Replace hose bracket kit and roller carrier	52
9.3.2	Renew hose on hose bracket	53
9.4	Cleaning of the fog maker container	54
9.5	Faults	54
9.5.1	General safety notices.....	54
9.5.2	Fault indications	55
9.5.3	Fault removal.....	56
10	Decommissioning / Storage / Disposal	57
10.1	Decommissioning	57
10.2	Storage	57
10.3	Recommissioning.....	57
10.4	Disposal	58
11	Documents.....	59
11.1	Declaration of conformity	59
11.2	Wiring diagrams	60
11.3	Commissioning protocol.....	62
11.4	Operation data sheet	62
11.5	Maintenance protocol.....	63
11.6	Disinfection protocol	63
11.7	Spare parts / wear parts / consumables	64
12	Appendices.....	64

1 About these instructions / general

1.1 Scope of applicability

These Operating and Installation Instructions describe the function, installation, commissioning and operation of the foam brine fogging system type SOLFOG V3. They must be read carefully before use and kept on the device for direct use, so that they are available at any time!

These Operating and Installation Instructions are an integral part of the device. If the product is resold, the Operating Instructions must be handed over to the new operator.

If you lose the documentation, you can download it from our website at: www.werner-dosiertechnik.de/Produkte/Wellness/Vernebelung-von-Soleloesung

1.2 Target group

Only our authorised partners and people who have been trained in the device functions are permitted to work on the system.



WARNING!

Danger of electric shock!

The system is under life-threatening voltage even during downtime!

- Electrical connection work may only be carried out by appropriately trained specialists!

1.3 Symbols used

This document uses the following types of safety notices as well as general notices:



DANGER!

“DANGER” denotes a safety notice which, if disregarded, will lead to serious or life-threatening injuries or death!



WARNING!

“WARNING” denotes a safety notice which, if disregarded, may lead to serious or life-threatening injuries or death!



WARNING!

Danger of electric shock!

This safety notice denotes danger due to electric shock, which, if disregarded, may lead to serious or life-threatening injuries or death!



CAUTION!

“Caution” denotes a safety notice which, if disregarded, may lead to injuries!



ATTENTION!

“ATTENTION” denotes a safety notice which, if disregarded, may lead to material damage or may impair the function of the system!



ATTENTION!

Danger due to static charge!

This safety notice denotes electronic components that may be damaged by electrostatic discharges.

The generally accepted safety precautions for ESD-sensitive devices must be observed when handling the devices!



NOTICE

A “Notice” denotes information that is of particular importance for the smooth running of operations and that can disrupt the operating process if not observed.



TIP

A “TIP” denotes information that may result in improvements in the operating process.



USE FACE PROTECTION!

Wear approved face protection to prevent facial injuries due to contact with hot or chemical materials.



USE PROTECTIVE APRON!

Wear an approved protective apron to prevent injuries to the front of your body due to contact with hot or chemical materials.



USE FOOT PROTECTION!

Wear approved foot protection to prevent injuries to the feet due to falling objects.

1.4 Further means of representation

The means of representation used in these instructions denote the following:

- General enumeration
- 1) Work or operating steps that should or must be carried out in the order listed.
- 01.** Numbering of elements (item numbers)
- Step that needs to be checked in particular
- Italics* Labelling of illustrations or plans

1.5 Warranty

All WDT devices and systems are manufactured using modern production methods and are subject to comprehensive quality control. However, should there be a reason for complaint, any compensation claims shall be directed to the company WDT in accordance with the general terms and conditions of warranty.

1.5.1 General terms and conditions of warranty

The company WDT assumes a 2-year warranty, starting with the commissioning, up to 27 months after delivery; subject to correct installation and commissioning with a completed and signed commissioning protocol.

Exempt from this are wear parts such as seals, hoses, diaphragms, dosing screws, electrodes, roller carriers and other parts that are subject to mechanical or chemical wear and tear. We issue a ½-year warranty for these.

Our enterprise resource planning system requires an invoice for each delivery (including warranty services). When returning a defective component, upon review you will receive a corresponding credit, if applicable. We request a return within 14 days.

The costs for subsequent damage and for the processing of warranty claims are excluded.

There are no warranty claims for damage caused by frost, water and electrical overvoltage or by improper handling.



CAUTION!

In the event of any unauthorised modifications to the device, the warranty and product liability will be voided!



NOTICE

In order to protect the warranty claims, please mail the completed commissioning protocol, along with the defective component, to the company WDT.

Without the commissioning protocol, we reserve the right to an exclusion of warranty.

1.6 Additional information

Additional information concerning specific topics, such as design of the dosing performance or description of the operating parameters, may be obtained from your specialist dealer, or directly from:

WDT – Werner Dosiertechnik GmbH & Co. KG
Hettlinger Str. 17
D-86637 Wertingen-Geratshofen, Germany

Phone: +49 8272 / 98697- 0 (Switchboard)
Phone: +49 8272 / 98697- 380 (Technical Hotline)
Fax: +49 8272 / 98697 - 19
Web: www.werner-dosiertechnik.de
Mail: info@werner-dosiertechnik.de

1.7 Information regarding support queries/ identification plate

The control unit of the brine fog maker type SOLFOG V3 is subject to continued further development of both its firmware and hardware. We always strive to preserve the compatibility of the components used.

For spare part orders, we require the following data. You can find these on the identification plate.

- Device designation
- Device serial number
- Date of manufacturing

Enter the data from your device's identification plate here.

Typ: Soldos V3
Art.: <input type="text"/> Serien Nr.: <input type="text"/>
230V - 1~ 50Hz - P: 50 W
 Herstellung <input type="text"/>
WDT - Werner Dosiertechnik GmbH & Co KG
Hettlinger Str. 17
D-86637-Wertingen
Made in Germany

Field 1: Enter code number

Field 2: Enter serial number

Field 3: Enter date of manufacturing

In addition, we require the following data for technical support queries. These are located in the menu item **Menu** ▶ **Service** ▶ **Info**.

- current software version
- Serial number



NOTICE

Keep the identification plate clean and in a legible condition!

2 Safety notices

2.1 Intended use

The brine fog maker SOLFOG V3 is used to create a saline ocean climate in relaxation rooms, saline rooms, infrared cabins and saunas.



WARNING!

Health hazard due to unsuitable brine and fragrance oil concentrates!

- Use only highly pure, disinfected WDT brine solution!
- Only use fragrance oil concentrates that have been approved for room scenting!



ATTENTION!

Damage to the device due to incorrect installation!

- The device may only be installed and operated in the technical room!
- Pay attention to the information in the technical data on page 15.

Intended use also includes compliance with all conditions and safety instructions prescribed by WDT in accordance with these instructions for:

- Installation
- Dismantling
- Reinstallation after decommissioning
- Commissioning
- Operation
- Maintenance/servicing
- Disposal

The attachment or installation of additional equipment is only permitted with the manufacturer's written approval.

Pay attention to the nationally applicable regulations for environmental and drinking water protection!

2.2 Personnel



WARNING!

Restricted user group!

This device is not intended to be used unsupervised by persons (including children) with reduced physical, sensory or mental capabilities, or lack of experience and/or knowledge.

- A person responsible for the safety of this group of users must be entrusted with supervision and must give appropriate instructions for operation.
- Children must be supervised to ensure that they do not play with the device!

Work on the device and changes in the settings may only be carried out by properly instructed persons or persons who have read and understood the Operating Instructions!

The personnel must be informed by the operator of any hazards that may occur. A copy of the Operating Instructions must be left at the device's place of use.

Persons who transport or work on and with the device must have read and understood the relevant parts of the Operating Instructions, and in particular the chapter “Safety notices” starting on page 9.

Pay attention to the nationally applicable regulations for accident prevention and work safety!

2.3 Electrical system



WARNING!

Danger of electric shock!

Dangerous electrical voltage!

- All work on the device must be carried out by specialist personnel only!
- All electrical installations and any work on the device’s electrical components must be carried out by authorised electricians only!
- Prior to starting work, disconnect the devices from the power supply and secure them against being reactivated!
- Pay attention to the warning notices on the device
- After corresponding electrical installation or repair, test all protective measures used (e.g., earthing resistance)!



ATTENTION!

Damage to the device due to an unsuitable fuse!

- Use only the original fuses with the prescribed current rating!
- Regularly check the device’s electrical equipment!
- Immediately eliminate defects such as loose connections, scorched cables or damaged electrical insulation!

The installing specialist company is responsible for an intrinsically safe installation of the WDT brine fog maker.

2.4 Operation of the device



WARNING!

Pay attention to all of the safety and warning notices located on the device!



WARNING!

Health hazard due to unsuitable brine and fragrance oil concentrates!

- Use only highly pure, disinfected WDT brine!
- Carry out a disinfection every 28 days!
- Only use fragrance oil concentrates that have been approved for room scenting!



WARNING!

Danger of irritation and/or allergic reactions!



Undiluted fragrance concentrates or disinfectants may cause irritation and allergic reactions!



- Do not drink, smoke or rub in!
- Do not allow to come into contact with skin or eyes!
- Keep out of the reach of children!
- Use fragrance oil concentrates only for room scenting with the SOLFOG!
- Only use as approved by the manufacturer! Pay attention to the manufacturers' safety notices!
- Wear chemical-resistant protective gloves and goggles!
- Immediately absorb drip leaks of brine and fragrance oil concentrates with a suitable material, e.g., cotton cloth, and dispose of according to local regulations!



WARNING!

Ignition hazard!

Undiluted fragrance oil concentrates may be highly flammable!

- Pay attention to the rules for handling flammable liquids!
- Avoid ignition sources (e.g., hot surfaces, sparking, open fire or cigarettes)!

Carefully read and pay attention to the operating instructions prior to installation and use of the device!

In the event of malfunctions or faults in the electrical power supply, immediately switch off the device and secure it against being switched on again!

Faults on the device must be rectified immediately.



ATTENTION!

Damage to the device due to repeated switching on without rectifying the fault!

- Rectify any faults immediately!
- Carefully read and pay attention to the operating instructions prior to installation and use of the device!

The device may only be operated with a connected fog pipe that safely conducts the fog!

All protection and warning devices must be tested regularly in order to ensure proper function.

The device must be checked regularly according to the enclosed maintenance protocol.



WARNING!

Danger due to switched-off safety devices!

The device is equipped with numerous safety devices to protect your health.

- Never remove or deactivate safety devices during operation!
- Never operate the device without functioning safety devices!

3 Scope of delivery / accessories / functional description

3.1 Scope of delivery / accessories

The delivery consists of a ready-to-connect brine fog maker SOLFOG V3, comprising:

- Control unit CB36, mounted in the housing
- Peristaltic pump type SA for brine solution
- Ultrasonic fog maker with level switch, completely installed and wired on a mounting plate with console for 1 kg to 5 kg brine politainer
- Disinfection kit with disinfection tablet, mixing container and recipient
- 1 kg or 5 kg sterile brine solution in the politainer
- Inlet nozzle made of PVC, d 40 mm with nozzle washer.
- Optional: Button plate, including illuminated button with flush-mounted box
- Optional: Lighting system for fog outlet with stainless steel nozzle washer
- Optional: Fragrances for room scenting



NOTICE

When receiving the device, ensure that:

- the type and serial number on the identification plate correspond to the details in the ordering and delivery documents, and
- the equipment is complete and all parts are in perfect condition.

In the event of any transport damage and/or missing parts, immediately notify the forwarding agent or supplier in writing.

Pay attention to the deadlines for notifying the transport companies for the purpose of assessing damage.

3.2 Structure of the overall system

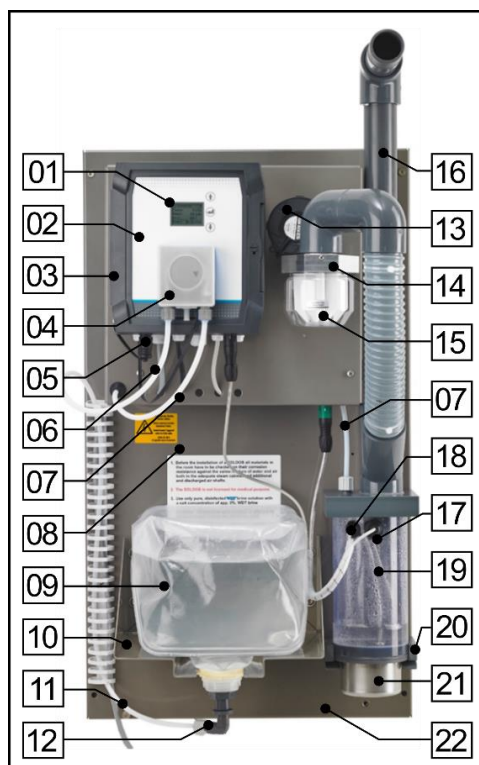

- 01 Display with 3 operating buttons
- 02 Control housing
- 03 Main switch (covered, see Fig. 38)
- 04 Peristaltic pump
- 05 Coupling for button connection
- 06 Suction line for brine solution
- 07 Pressure line for brine solution
- 08 Warning notices
- 09 Brine politainer
- 10 Console for brine politainer
- 11 Additional earth connection
- 12 Plug-in politainer connection
- 13 Fan
- 14 Bracket for fragrance container with non-return valve
- 15 Fragrance container with filter star
- 16 Outlet pipe for brine fog maker
- 17 Level control for fog maker container
- 18 Cable for ultrasonic fog maker
- 19 Fog maker container
- 20 Bracket for fog maker container
- 21 Ultrasonic fog maker
- 22 Mounting plate

Fig. 1: Overall system brine fogging type SOLFOG V3

3.3 Functional description

The brine fog maker SOLFOG V3 is used to create a saline ocean climate in relaxation rooms, saline rooms, infrared cabins and saunas. The brine fog maker vaporises the brine by means of an ultrasonic fog maker. The vaporised brine is conducted into the cabin via an air stream generated by the fan.

A level switch is used to control a *peristaltic pump* (Fig. 1, No. 04), which feeds additional brine into the fog maker container. This replaces the consumed brine.

Optionally, a fragrance can also be blown into the room along with the fog. For this purpose, the *fragrance container* (Fig. 1, No. 15) must be filled up to the mark (maximum 50 ml) with a fragrance oil concentrate for room scenting, and a filter star must be inserted. The fan blows the evaporating fragrance oil concentrate through a *non-return valve* (Fig. 1, No. 14) into the fog maker container. There, the fragrance oil concentrate mixes with the brine fog and is blown into the connected cabin.

By default, the device is started with the main switch. Optionally, the device can be controlled via a push button from the cabin or via an external signal.

Operation without brine

If the SOLFOG is only to be used to vaporise water instead of brine, this can be done with a water politainer or a fixed water connection. With a direct connection to the water line, the politainer is replaced by a fixed ½" water connection and a solenoid valve.

3.4 Description of components

3.4.1 Control unit



Fig. 2: Control unit

The control unit consists of the *control housing* (Fig. 1, No. 02) with protection class IP64.

The electronic components are installed in the housing.

On the control unit, the operating parameters can be set on a 5-line LCD display by means of 3 operating buttons.

3.4.2 Brine dosing

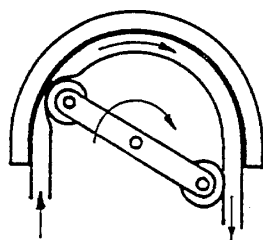

Fig. 3: Peristaltic pump function

Brine dosing is performed using a *peristaltic pump* (Fig. 1, No. 04), which can reliably transport even the smallest dosing quantities; even when air or gas bubbles are trapped in the suction line.

The rotating rollers press the dosing hose against the wall, which pushes the liquid in the hose out in front of the rollers while simultaneously sucking more liquid in behind them.

The peristaltic pump is exceptionally reliable and also very easy to operate.

3.4.3 Ultrasonic fog maker



Fig. 4: Ultrasonic fog maker

The *ultrasonic fog maker* (Fig. 1, No. 21) turns the brine solution in the *fog maker container* (Fig. 1, No. 19) into a finely vaporised fog.

The *fan* (Fig. 1, No. 13) blows this fog into the cabin.

3.4.4 Dosing unit for the scenting



Fig. 5: Fragrance dosing

Along with the fog, a pleasant fragrance can also be blown into the room.

For this purpose, the *fragrance container* (Fig. 1, No. 15) must be filled up to the mark (**max. 50 ml**) with a fragrance oil concentrate for room scenting, and a filter star must be inserted.

The *fan* (Fig. 1, No. 13) blows the evaporating fragrance oil concentrate through a *non-return valve* (Fig. 1, No. 14) into the fog maker container.

There, the fragrance oil concentrate mixes with the brine fog and is blown into the connected cabin.

3.4.5 Button plate (option)



Fig. 6: Button plate, sample illustration

Button plate with flush-mounted box for starting the brine fogging.

For details about the flush-mounted box, see supplementary sheet "**BB DW 001-03 Installation of flush-mounted box V2**" in *Chapter 12*.

Additional options:

- Button plate made of stainless steel, corian, wood, etc.
- Steam room button

3.4.6 Lighting system for fog outlet (option)



Fig. 7: Fragrance dosing

The fog lighting system imparts a pleasing colour to the brine fog.

The colours blue or white are available. The ordered colour was preset in the factory.

The lighting system consists of:

- a special bend with an opening for the lighting rod
- the lighting rod with LED connection cable and plug
- a built-in socket pre-installed in the control housing
- a chrome-plated washer at the fog outlet into the cabin

3.5 Technical data

SOLFOG V3	
Dimensions and weights	
External dimensions	WxHxD: 0.40 x 0.71 x 0.25 m
Space requirement	WxHxD: 0.50 x 0.90 x 0.30 m
Space requirement, including operation and maintenance	WxHxD: 0.60 x 2.00 x 1.00 m
Empty weight/operating weight	11 kg / 16 kg
Connection data	
Fog maker pipe connection	D 40 mm
Electrical connection	110 - 230 V AC/ 50/60 Hz, 50 W, plug
Main fuse	Fine wire fuse 8.3x8 mm, 2 A slow
Nominal pressure / operating pressure	Max. 192 pascal
Operating data	
Evaporation performance	max. 0.5 l/h
Medium temperature	+5 to +35°C
Ambient temperature technical room	+10 to +35°C
Humidity technical room	max. 70%
Ventilation (in and out)	Recommended in the technical room
Software version	---
Hardware version	CB 36

Table 1: Technical data

4 Transport and storage

4.1 General safety notices



ATTENTION!

Damage to the device due to improper transport!

- The device must only be transported in its original packaging!
- When transporting the WDT brine fog maker, proceed with caution to prevent damage due to force or careless loading and unloading.
- Avoid exposure to frost during transport!

4.2 Packaging



WARNING!

Danger of suffocation!

- Keep packaging and packaging residue, in particular plastic bags, out of reach of children!



NOTICE

Please pay attention to the notices and pictograms attached to the carton!

4.3 Temporary storage of the device



ATTENTION!

Damage to the device due to improper storage!

The device may be damaged by frost or high temperatures!

- Avoid exposure to frost during storage!
- Do not store systems and devices next to objects with strong heat emission or in direct sunlight.
- The device must only be stored in its original packaging. Please ensure careful handling.

4.4 Storage of fragrance oil concentrates / brine

Pay attention to the fragrance oil concentrate manufacturers' data sheets regarding storage as well as the local regulations for occupational safety and for environmental and drinking water protection!

5 Mechanical installation

5.1 General safety notices



WARNING!

Risk of injury!

Personnel who are not familiar with professional installation methods may suffer bodily harm!

- The installation of this device may only be carried out by qualified personnel (persons who have completed training in the field of sanitation or in the field of electrical installation)!



CAUTION!

Danger of foot injuries!

The device can fall down when installed by a single person!

- Always carry out the installation with 2 persons!



WDT accepts no liability for damage caused by incorrect installation!

The attachment or installation of additional equipment is only permitted with the manufacturer's written approval; otherwise any warranty will be voided.

5.2 Select the installation site



ATTENTION!

Damage to the device due to an unsuitable installation site!

- Installation is only permitted in the technical room!
- Pay attention to the information regarding the installation site and the technical room in the technical data on *page 14!*

The installation site must have the following properties:

- The installation site must be frost-proof.
- The system must be protected from direct sunlight.
- An electrical power connection with a safety contact is required.
- It is recommended that the storage space be well aerated and ventilated.
- Prior to installing the device, all materials of the cabin as well as the supply and exhaust air shafts must be checked for corrosion resistance to the saline water/air mixture in the room.
- The brine fog maker's control unit is IP64 protected. Please ensure that the device is not exposed to splashing water at the place of installation.

5.3 Installation notices

The SOLFOG V3 is installed on a wall in the technical room.

The line to the cabin should be as short as possible (max. 4 m) and must be installed with a gradient of at least 1° towards the device. Condensing liquids should be able to run back into the device. We recommend using PVC bends instead of PVC brackets.

Prior to starting the installation, the following tasks must be carried out:

- Remove transport safety devices.
- Warning and information signs must be installed in compliance with locally applicable accident prevention regulations (OSHA) at the locations provided.

5.4 Install SOLFOG V3



CAUTION!

Danger of foot injuries!



The device can fall down when installed by a single person!

- Always carry out the installation with 2 persons!

With the exception of the roller carrier and the brine solution, the SOLFOG V3 is delivered ready for operation. It should be installed in an easily accessible location.

Securely attach the mounting plate to the wall with 4 screws and ensure easy accessibility.



ATTENTION!

Damage to the device due to improper wall attachment!

At unsuitable walls (e.g., porous or unstable) or with inadequately dimensioned fastening material (e.g., screws that are too short or unsuitable dowels), the device may detach from the wall!

- Pay attention to the device's operating weight according to the technical data on *page 15*!
- The wall and the fastening material must be able to bear the specified operating weight!

5.5 Fog maker pipe connection

Install the *outlet pipe* (Fig. 1, No. 16) in the cabin up to the fog inlet hole.



NOTICE

The piping material is not included in the scope of delivery!

5.5.1 Install the piping



WARNING!

Risk of germ contamination!

Improper installation of the fog line can lead to the formation of water traps, where bacteria or germs may occur.

- The pipeline must not exceed a length of 4 m!
- The pipeline may include no more than 5 bends!
No brackets may be installed!
- Install the fog line with a gradient and without water trap, so that the condensation water can run back to the brine fog maker and does not remain in the line.
- The gradient must be 1 cm per 1 m of line length (corresponds to 1% gradient)!

Installation plan

Installation without lighting system

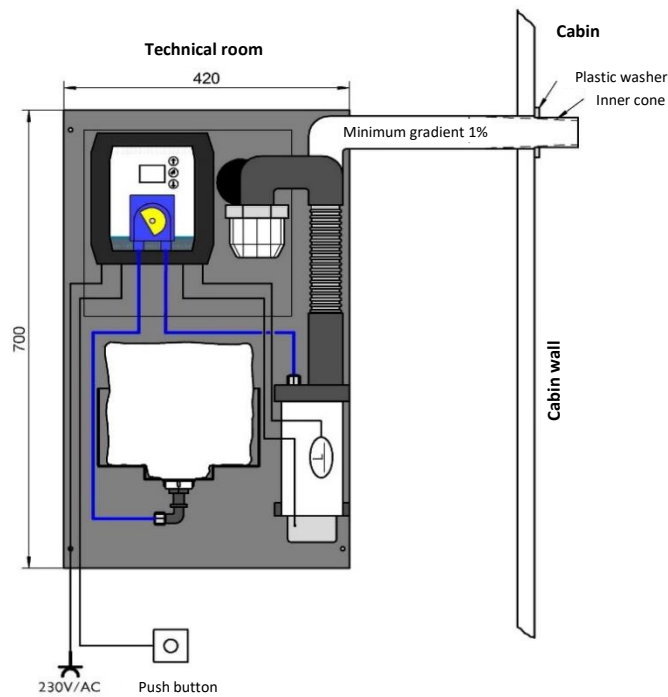

Fig. 8: Installation plan SOLFOG V3 without lighting system

Installation with lighting system

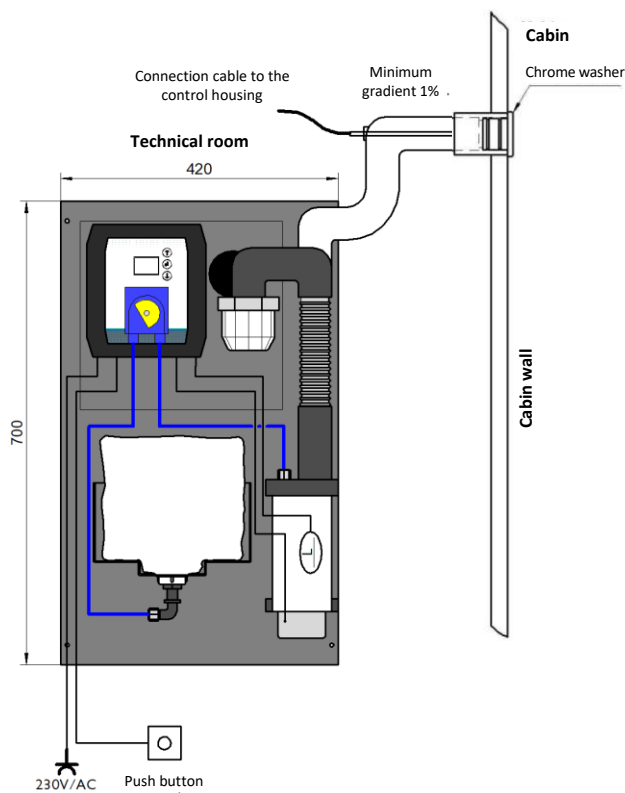

Fig. 9: Installation plan SOLFOG V3 with lighting system



ATTENTION!

Install the fog line with a gradient (minimum 1%) and without water trap, so that the condensation water can run back to the fog maker container and does not remain in the line. This is necessary for reasons of hygiene to avoid the formation of larger germ concentrations!

Piping without fog lighting system

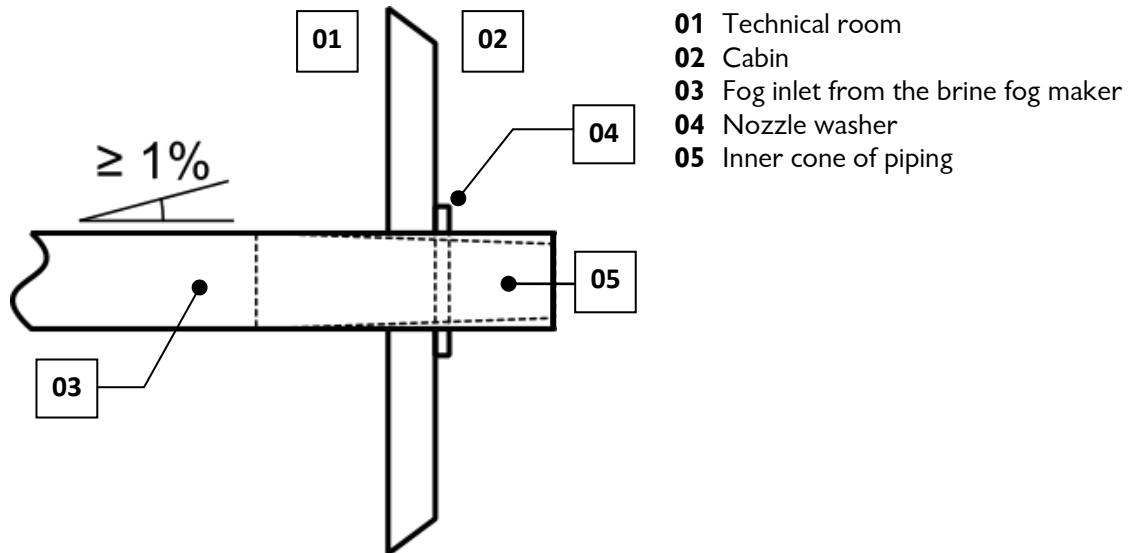
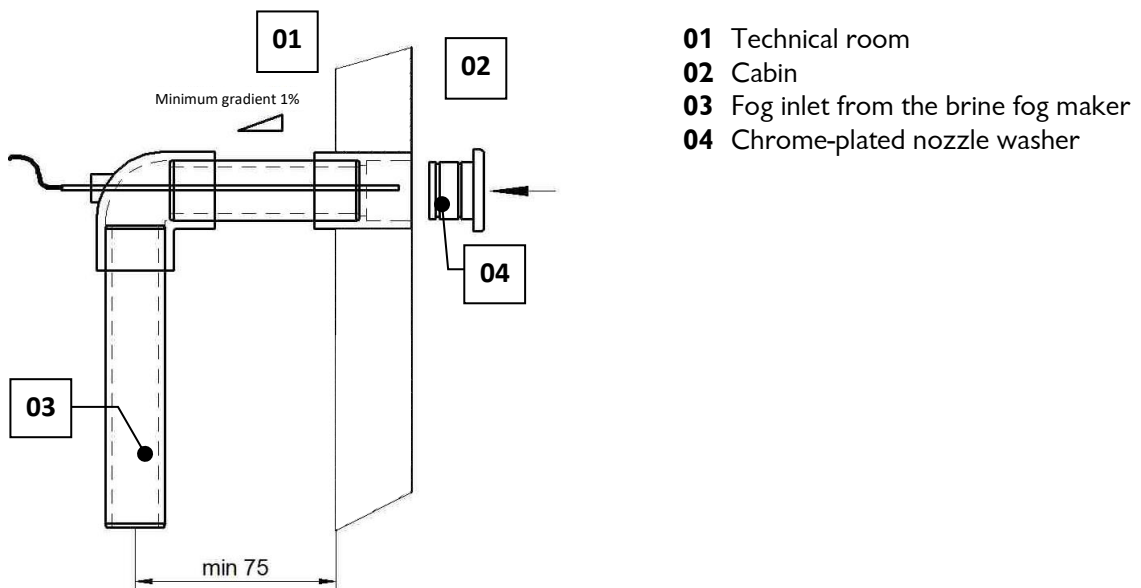

Fig. 10: Installation plan fog pipe

To install the piping, proceed as follows:

- 1) Find a suitable location for the fog inlet into the cabin.
- 2) Drill a 40 mm hole in the cabin wall.
- 3) Install the fog line from the brine fog maker to the cabin using a pipe with a 40 mm diameter. Maximum line length 4 m. Pay attention to the gradient in the line.
- 4) Install the nozzle washer on the sauna wall.

Piping with fog lighting and chrome washer (option)



To install the piping, proceed as follows:

- 1) Find a suitable location for the fog inlet into the cabin.
- 2) Drill a 47 mm hole in the cabin wall.
- 3) Install the fog line from the brine fog maker to the cabin using a pipe with a 40 mm diameter. Maximum line length 4 m. Connect the special bend with the vertical fog maker pipe and connect it to the SOLFOG's outlet pipe. Pay attention to the gradient in the line.
- 4) Push the lighting rod into the special bend and connect the cable on the control housing. The built-in socket and the software programme for the fog lighting are already installed during production of the SOLFOG.
- 5) Install the chrome-plated nozzle washer on the sauna wall.

6 Electrical installation

6.1 Safety notices



WARNING!

Danger of electric shock!

Dangerous electrical voltage!

- All work on the device must be carried out by specialist personnel only!
- All electrical installations and any work on the device's electrical components must be carried out by authorised electricians only!
- Prior to starting work, disconnect the devices from the power supply and secure them against being reactivated!
- After corresponding electrical installation or repair, test all protective measures used (e.g., earthing resistance)!

6.2 Electrical connection

- 1) For additional equipotential bonding, an earthing connection (page 12, pos. 11) is provided on the mounting plate.
- 2) Connect the SOLFOG to the power supply (110-230 V AC, 50/60 Hz) with the power plug.

6.3 Additional connection options

The following additional connection options exist:

Description	Bar	Terminals
Collective fault to CCS (Central Control System)	SL 4	1/2/3
Operating contact with a potential-free signal <ul style="list-style-type: none"> • When the operating contact is open, the device is in standby position (e.g., during downtimes) • When the operating contact is closed, the device is ready for operation (e.g., during operation times) 	SL 13	4/5
External control (e.g., via central control or BCS) <ul style="list-style-type: none"> • The device can be activated (fog on) or deactivated (standby position) via the external contact. • As long as the contact is closed, fog is produced. • The contact is only active when the "EXTERNAL" operation mode is selected. • The dosing time and pause time can be specified with an external control unit. 	SL 10	4/5



NOTICE

Electric wiring: See wiring diagram in *Chapter 11.2 on page 60*.

7 Commissioning

7.1 General safety notices



WARNING!

Risk of injury!



Possible injury to fingers (crushing) and irritation of skin and eyes!



Do not allow to come into contact with skin or eyes!

- Prior to starting work, read and understand the Operating Instructions!
- Wear goggles and protective gloves!
- The tasks described here must only be performed by appropriately qualified personnel from a specialist company.
- Prior to commissioning, the installed systems must be checked for proper installation and leaks.



WARNING!

Danger of irritation or and allergic reactions!



Undiluted fragrance oil concentrates may cause irritation and allergic reactions!



- Do not drink, smoke or rub in!
- Use fragrance oil concentrates only for room scenting with the SOLFOG!
- Keep out of the reach of children!
- Do not allow to come into contact with skin or eyes!
- Wear chemical-resistant protective gloves and goggles!



ATTENTION!

Damage to the device due to incorrect commissioning!

- The sequence of the following commissioning steps must be observed!
- The information in the commissioning protocol must be observed!

7.2 General remarks

During commissioning, a distinction is made between

- initial commissioning following installation
- recommissioning following politainer replacement or after extended downtime

The device comes loaded with ex works settings.

Adjust the control parameters to the desired operation mode during initial commissioning and enter them in the operation data sheet in Chapter 11.4 on page 62.

7.3 Commissioning steps

- 1) Insert the roller carrier in the fragrance pump (see Chapter 7.5 on page 24).
- 2) Carry out disinfection (see Chapter 7.8 on page 27).
- 3) Insert/change the brine politainer (see Chapter 7.9 on page 33).

7.4 Display and controls

There are 3 operating buttons next to the LCD display. They are used to navigate in the menu.



NOTICE

The display had a dim function:

If no input occurs for **60 seconds** on the control unit, the backlighting is dimmed. An initial pressing of a key (arrow keys, Enter key) only reactivates the backlighting.



Fig. 12: Display and controls

71

71 Display

72

72 3 operating buttons:

Navigation upwards 

Use the arrow key to navigate upwards or set numerical values.

Enter 

Use the Enter key to navigate to the selected submenu or to the next setting value or to confirm the setting value.

Navigation downwards 

Use the arrow key to navigate downwards or set numerical values.

7.5 Insert the roller carrier at the fragrance pump



WARNING!

Risk of crushing!



Injury to fingers (crushing) possible!

- **Only conduct the work when the device has been switched off and secured against being reactivated!**

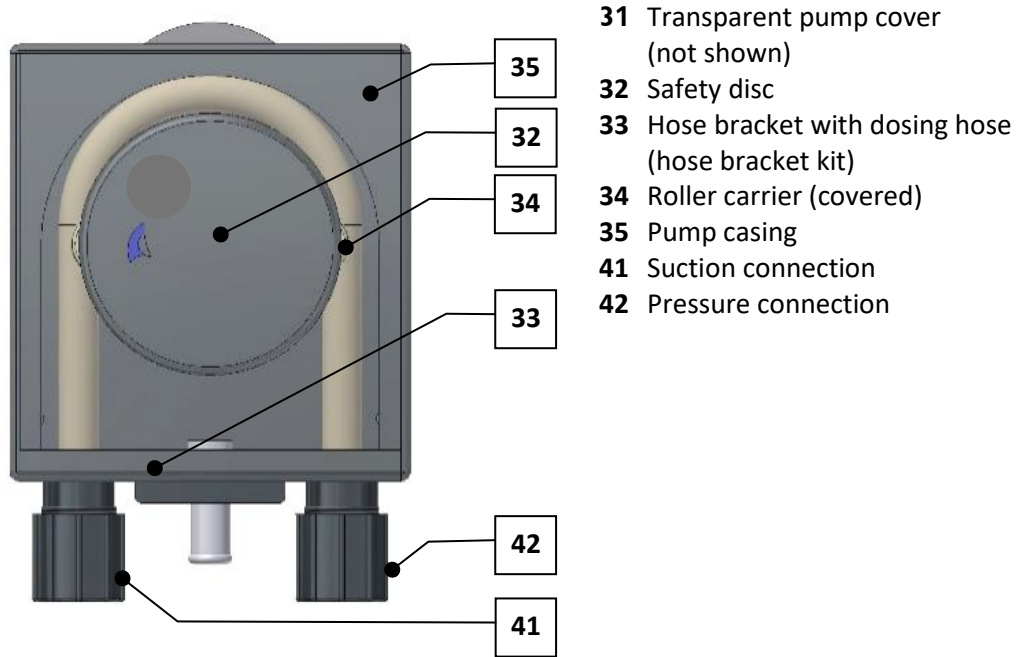

Fig. 13: Peristaltic pump

ATTENTION!



Faulty operation due to an unsuitable hose!

The peristaltic pump is fitted with a white dosing hose. For dimensions, see Technical data in *Chapter 3.5*.

Dosing hoses with other colours are made of different material and may have different dimensions.

This may lead to faulty operation!

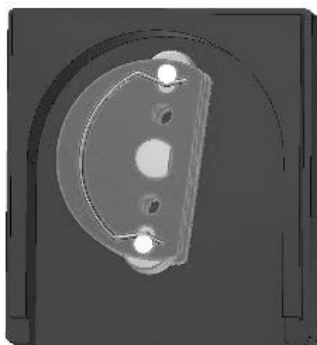

Fig. 14: Insert roller carrier

- 1) Remove the clipped-in transparent *pump cover* (Fig. 13, No. 31) and the *safety disc* (Fig. 13, No. 32) from the *pump casing* (Fig. 13, No. 35).

At initial commissioning, these parts can be found loose in the enclosed bag.

- 2) Pull the *hose bracket* (Fig. 13, No. 33) out of the guide in the housing.
- 3) Push the *roller carrier* (Fig. 13, No. 34) onto the shaft.

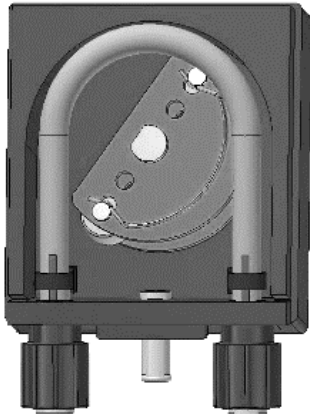

Fig. 15: Insert the hose bracket

- 4) Insert the *hose bracket* (Fig. 13, No. 33) into the housing guides until it locks into place completely.

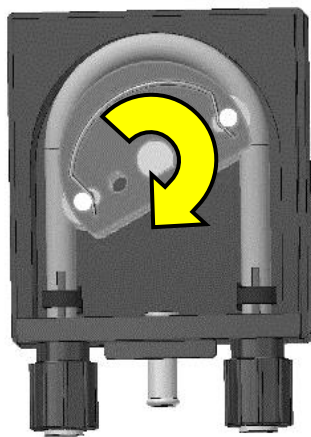

Fig. 16: Turn the roller carrier

- 5) Turn the *roller carrier* (Fig. 13, No. 34) clockwise while carefully pressing the hose into the housing at the **roller carrier's flat side** until the entire hose is completely contained in the housing.
- 6) Now replace the safety disc and the transparent pump cover.

The installation of the roller carrier is now completed.

7.6 Disassembling the roller carrier

The roller carrier and hose bracket are disassembled in the reverse order.

7.7 Switching on the device



NOTICE

When the device is switched on for the first time, or after a reset, the device starts automatically with the start query.

7.7.1 Start query / initial start of the device

After switching on the device for the first time, or after resetting it to the factory settings, the language and the parameters for pause time, fogging time and operation mode must first be entered. The corresponding displays are shown in sequence.

After successful entry, the device is ready for operation.

7.7.2 Reactivating the device

Solfog	☉ ◯ ▲ ■
Pause	01:59
Fog	00:06
Cycle	30:00
08:19	Thu 17:00

Fig. 17: Display with operation display

After reactivation, the device starts in the operation display and is immediately ready for operation.

The display is illuminated.

The display shows the set times for:

- the pause time,
- the fogging time and
- the cycle time (only for “Push button” operation mode).

The current time is shown on the bottom row to the left.

When the timer is activated, the next switch time is shown at the centre/right (e.g., Thu 5:00 p.m.).

7.8 Carry out disinfection with politainer change

7.8.1 General information regarding disinfection



CAUTION!

Health hazard due to lack of disinfection!

- It is of particular importance to regularly carry out disinfection as a protection against germs and bacteria. The Hypochlorous acid/hypochlorite required for disinfection is generated by dissolving the enclosed disinfection tablet (Code no. 19871).
- Each disinfection must be documented in the disinfection protocol!

7 days downtime

- In case of a downtime of **up to 7 days**, the device can be recommissioned without disinfection.
- If the device has not been operated for **more than 7 days**, this must be documented in the disinfection protocol, and a disinfection must be carried out at start of operation!

28 days operation



CAUTION!

Health hazard due to limited shelf life of the brine!

After opening, the brine politainer has a maximum shelf life of 28 days!

- **Dispose of the brine politainer with the residual content once this shelf life has expired!**
- The brine politainer must be changed at least **every 28 days** and a disinfection must be carried out.
- On the 25th day, the display shows a message that a disinfection will be required in 3 days, at the latest.

- The disinfection must be documented in the disinfection protocol, regardless of how long the device was in operation during this time!



Disinfection

A disinfection must be carried out **during each politainer change**, or at least every **28 days!**

7.8.2 Disinfection procedure

To carry out a disinfection, proceed as follows:

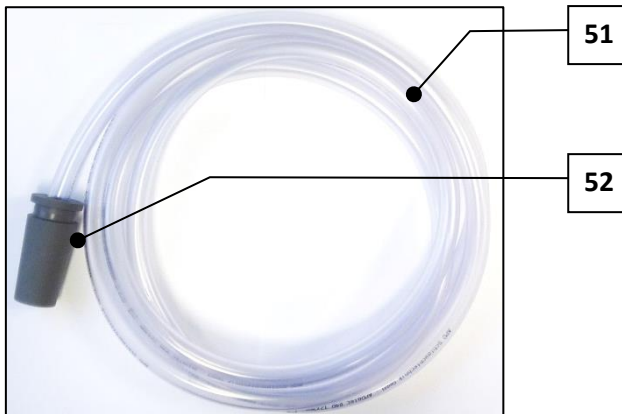

For disinfection, keep the connection kit (51) with nozzle adapter (52) at hand.

Fig. 18: Connection kit for the disinfection

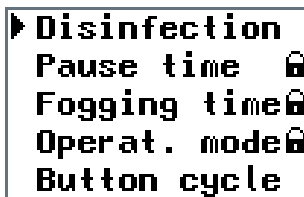



Fig. 19: Menu: Disinfection

- 1) To carry out the disinfection, switch on the system at the *main switch* (Fig. 38, No. 03).

Select the **Disinfection** menu using the arrow keys and confirm with the Enter key .



NOTICE

You can navigate back to the main menu at any time by using the ESC key in the Disinfection submenu.

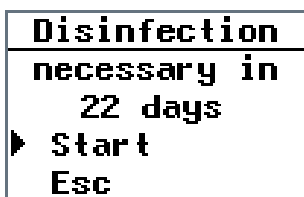



Fig. 20: Menu: Start disinfection

- 2) Select **start** using the operating buttons, start with the Enter key  and follow the programme guide.



NOTICE

The disinfection programme that has been started can only be cancelled by switching it off at the main switch. After that, the message “Disinfection necessary” is displayed every time the device is switched on. The display “Disinfection necessary in 0 days” can be hidden with Esc/Enter in order to be able to continue operating the system for a short time until the next disinfection.

**Empty,
rinse and
insert the
Fog container**

Fig. 21: Menu: Rinse fog maker container

- 3) Loosen the two cable couplings. Pull the *Fog maker container (Fig. 13, No. 19)* forwards out of the bracket and remove it downwards.
- 4) Empty the fog maker container, rinse it with drinking water and replace the empty fog maker container. Re-connect the two cables.
- 5) Leave the menu with the Enter key .



NOTICE

The fog maker container must be empty in order to proceed to the next step in the Disinfection menu using the Enter key. Removing and inserting the fog maker container requires some effort! Loud snapping sounds are normal.

**Fill poli-
tainer with
disinfection
solution**

Fig. 22: Menu: Fill politainer

- 6) Fill the enclosed empty 1 litre brine politainer with 0.5 litres of water
- 7) Add the enclosed disinfection tablet SOLDOS (Code no. 19871) and let it dissolve. (Dissolving the disinfection tablet generates the Hypochlorous acid/hypochlorite required for disinfection.) ...”



WARNING!

Danger of irritation or and allergic reactions!

Disinfectants may cause irritation and allergic reactions!

- Do not drink!
- Keep out of the reach of children!
- Do not allow to come into contact with skin or eyes!
- Wear chemical-resistant protective gloves and goggles!
- Block access to the application room/cabin during disinfection!
- Collect the escaping disinfection solution in a plastic container or channel it directly into the drain. Pay attention to the nationally applicable regulations for environmental and drinking water protection!



Fig. 23: Pull off politainer connection

- 8) Remove the brine politainer from the console and unscrew the original lid from the politainer.
- 9) Pull the politainer connection from the suction line's Connecting plug



Fig. 24: Screw in politainer connection

10) Screw the politainer connection onto the politainer with disinfection solution.



Fig. 25: Insert the suction line

11) Insert the suction line with the *Connecting* plug in the politainer connection.



Fig. 26: Push the politainer into the console

12) Turn the connected politainer upside down and push it into the console.

Ensure that the yellow flange ring rests in the groove intended for this purpose!

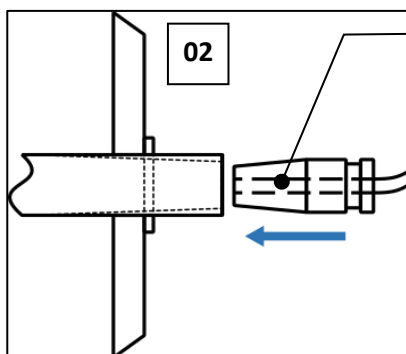

Fig. 27: Push on nozzle adapter

13) Attach the *nozzle adapter* (Fig. 27, No. 52) of the enclosed *connection kit* (Fig. 18, No. 51) on the fog outlet in the corresponding *cabin* (Fig. 27, No. 02).

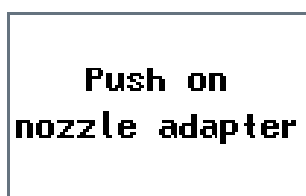



Fig. 28: Menu: Push on nozzle adapter

14) Confirm the message **Push on nozzle adapter** with the Enter key .

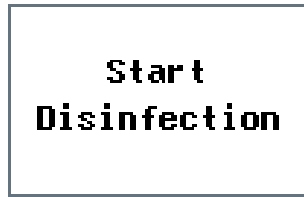



Fig. 29: Menu: Start disinfection

- 15) Start the disinfection with the Enter key .

The disinfection runs independently and takes 15 minutes.



Fig. 30: Menu: Info disinfection

The peristaltic pump delivers the disinfection solution into the fog maker container until the required fill level is reached.

The disinfection solution is vaporised by the ultrasonic fog maker and blown through the fan into the fog maker pipe and the connection kit.

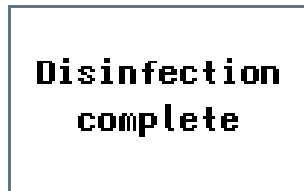

Fig. 31: Menu: Disinfection complete



- 16) Confirm the display message **Disinfection complete** with the Enter key  and follow the sequence on the display.



Fig. 32: Menu: Remove nozzle adapter

- 17) Remove the nozzle adapter at the fog outlet.

- 18) Confirm the display message **Remove nozzle adapter** with the Enter key .



NOTICE

Removing and inserting the fog maker container requires some effort!
Loud snapping sounds are normal.

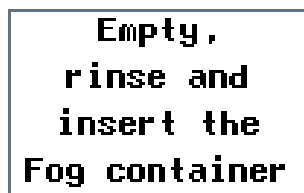

Fig. 33: Menu: Rinse fog maker container

see following page



Fig. 34: Remove fog maker container

- 19) Pull the *Fog* maker container (Fig. 13, No. 19) forwards out of the bracket and remove it downwards.
- 20) Empty the fog maker container, rinse it with drinking water and then replace the empty fog maker container.
- 21) Confirm the display message “Rinse, empty and insert fog maker container” with the Enter key↵

NOTICE

The fog maker container must be empty in order to exit the Disinfection menu using the Enter key ↵.

- 22) Disassemble, empty and dry the politainer with the residual cleaning solution.
- 23) Only then can the politainer be reused for the next disinfection!



WARNING!

Risk of crushing!



Injury to fingers (crushing) possible!

- **Wear thin gloves when changing the fog maker container!**

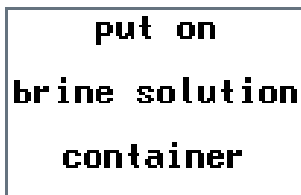

Fig. 35: Menu: New brine container

- 24) Connect and attach a **new** brine politainer.
- 25) Confirm the display message **Put on brine container** with the Enter key ↵.

The display returns to the main menu.
The device is ready for operation again.



NOTICE

The disinfection must be completed and terminated with the Enter key ↵ until the main menu is displayed; otherwise, a new disinfection is requested.

The disinfection programme that has been started can be cancelled by switching it off at the main switch.

Each disinfection must be documented in the disinfection protocol!

7.9 Inserting/changing the brine politainer



CAUTION!

Health hazard due to lack of disinfection!

- Always carry out a disinfection prior to inserting the politainer!
- We urgently recommend that you only use a highly pure, disinfected WDT brine solution.

To connect a new, unused brine politainer with a 5% brine solution to the dosing line, proceed as follows:

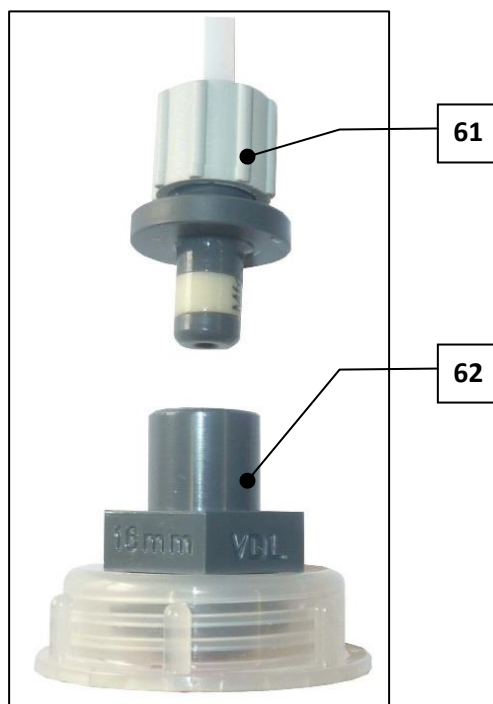

Fig. 36: Politainer connection

- 1) Remove the empty brine politainer from the console and turn the orifice so it faces upwards.
- 2) Now pull the *connecting plug* (Fig. 36, No. 61) out of the connecting sleeve of the *politainer connection* (Fig. 36, No. 61) and hold the empty brine politainer in your hand with the **lid pointing upwards**.
- 3) Unscrew the politainer connection from the empty politainer.
- 4) Take a new brine politainer (1 kg or 5 kg), hold it with the lid pointing upwards and open the brine politainer's lid.

The politainer is now open!

- 5) Tightly screw the politainer connection onto the open brine politainer.
- 6) Press the entire air out of the politainer, then insert the connecting plug in the politainer connection's connecting sleeve.

The politainer is now closed again!

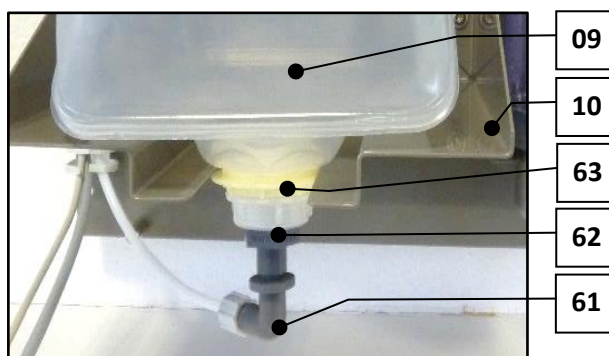

Fig. 37: Politainer connection with connecting plug

- 09 Brine politainer
- 10 Console
- 61 Connecting plug
- 62 Politainer connection with connecting sleeve canister connection
- 63 yellow collar ring

- 7) Turn the closed politainer 180° upside down and push it onto the *console* (Fig. 37, No. 10) so that the *yellow collar ring* (Fig. 37, No. 63) is located below the console. The device is now ready for use!

8 Operation / Use

8.1 General safety notices



WARNING!

Health hazard due to incorrect operation!

- Pay attention to all safety notices in these instructions, in particular the safety notices in the chapter 2 on page 9!
- The device must not be put into operation until the installation (mechanical and electrical) and the commissioning have been completed!
- The device must only be operated by trained and instructed personnel!
- Prior to operation, the operating personnel must have completely read and understood these instructions!



WARNING!

Danger of irritation or and allergic reactions!



Undiluted fragrance oil concentrates may cause irritation and allergic reactions!



- Do not drink, smoke or rub in!
- Use fragrance oil concentrates only for room scenting with the SOLFOG!
- Keep out of the reach of children!
- Do not allow to come into contact with skin or eyes!
- Wear chemical-resistant protective gloves and goggles!



WARNING!

Health hazard due to germ contamination!

Over-aged brine solution can lead to the formation of germs, which can enter the application room via the fogging and be inhaled there!

- A disinfection must be carried out after 7 days without operation or at least every 28 days!
- Check the use-by date before using a new brine solution!
- After opening, the brine has a maximum shelf life of 28 days! After that, the brine must be disposed of with the politainer!



NOTICE

Each disinfection must be documented in the disinfection protocol!

8.2 Check for operational readiness

- ☑ Check whether the power supply is ensured; connect the device, if necessary.
- ☑ Check the brine level in the politainer; replace politainer, if necessary.
- ☑ Check the fragrance oil concentrate level; replenish fragrance oil concentrate, if necessary.
- ☑ Check connections and peristaltic pump for leaks; restore proper seal, if necessary.
- ☑ Check whether a disinfection is required; carry out disinfection, if necessary.

8.3 Operation

The device is operated via the operating buttons next to the LCD display.

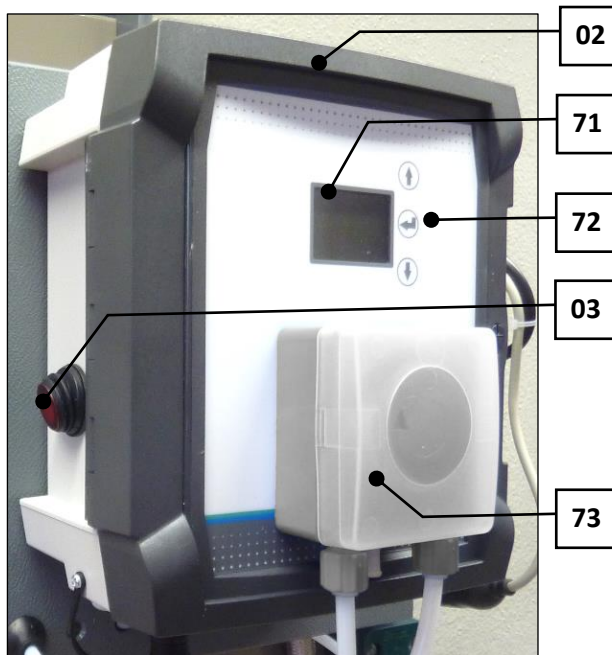

Fig. 38: Control unit with display

02 Control housing

03 Main switch

71 Display

72 3 operating buttons:

Navigation upwards 

Use the arrow key to navigate upwards or set numerical values.

Enter **key** 

Use the Enter key to navigate to the selected submenu or to the next setting value or to confirm the setting value.

Navigation downwards 

Use the arrow key to navigate downwards or set numerical values.

73 Dosing pump

8.4 Switching on / off



NOTICE

When the device is switched on for the first time after commissioning or after a reset, it starts automatically with the start query (see Chapter 7.7.1 on page 26).

The device is switched on at the *main switch* (Fig. 38, No. 03); it starts and is in the most recently selected operation mode.

The device is switched off at the *main switch* (Fig. 38, No. 03). The operating parameters are saved.



WARNING!

Health hazard due to germ contamination!

Extended downtimes can cause germ contamination in containers and lines!

- If the device is not used for an extended period of time, it must be emptied and cleaned (see notices on decommissioning in Chapter 10.1 on page 57!)
- After a downtime of more than 7 days, always start the commissioning with a disinfection!

8.5 Button plate function



Fig. 39: Button plate, sample illustration

Start the programme

Fog generation:

After pressing the button, the SOLFOG runs according to the set fogging and pause times until the cycle time has expired.

Restart the programme

If a push button is pressed again after the time has expired, the programme starts again.

Push button illumination

The push button illumination can be set individually. See Chapter 8.7.18, *Set Config / Push button illumination*.



8.6 Fog lighting function



Fig. 40: Fog lighting

The fog lighting starts and ends automatically, along with the SOLFOG's fog generation.

8.7 Control unit

The menu of the control unit is simply structured and easy to operate. It consists of the operating menu and the main menu with the following menu items, which can be reached via the arrow keys  and .

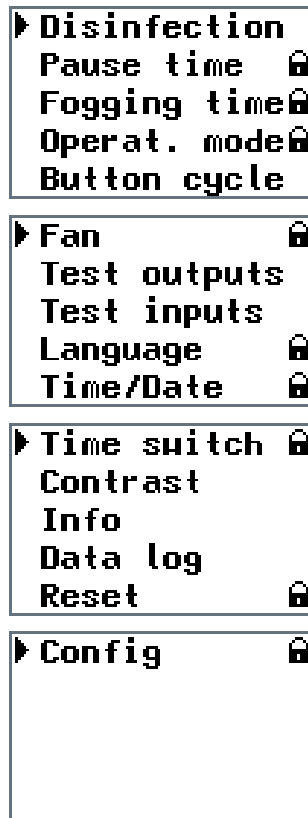





Fig. 41: Menu sequence

Pressing any Key (Fig. 38, No. 72) in the operating menu opens the main menu. Navigation is done via the arrow keys  and .

- 1) Disinfection
- 2) Pause time (password-protected)
- 3) Fogging time (password-protected)
- 4) Operation mode (password-protected)
- 5) Button cycle (only active with button operation)
- 6) Fan (password-protected)
- 7) Test outputs
- 8) Test Inputs
- 9) Language (password-protected)
- 10) Time/date (password-protected)
- 11) Time switch (password-protected)
- 12) Contrast
- 13) Info
- 14) Data log
- 15) Reset
- 16) Config

The black triangle on the left-hand side of the menu marks the currently selected list item.

The list entry is selected using the Enter key .

All parameters with the addition “password-protected” can be protected with a password by the operator.



NOTICE

Once you switch to the main menu, the operation of the system is interrupted so that changes can be made.

After exiting the main menu, operation is released again.

The main menu can be exited manually using the arrow key . After 30 seconds without any input, the control unit automatically switches from each submenu back to the operating menu. This does not apply to the test menus (output test/input test). These must be actively exited!

A start button (option) can be plugged into a socket on the control housing, as desired.

Password protection





Fig. 42: Password entry

Certain items in the operating level are marked with a padlock symbol.

The user password 0123 must be entered in order to be able to select these items.

The entry is made in sequence depending on the digit position. The active number is marked with an underscore.

Use the arrow keys  and  to count the corresponding number up or down and confirm with the Enter key .

If the password is entered incorrectly (after selecting the last digit on the right), the display lights up red and the system returns to the operating level.

8.7.1 Operation display

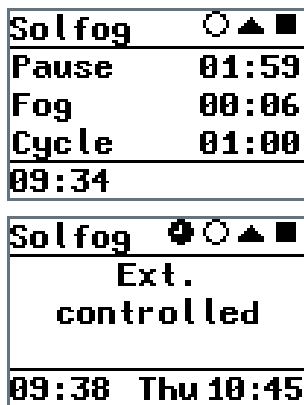

Fig. 43: Operation display









After switching on the device at the *main switch* (Fig. 38, No. 03) located on the side, the display shows the operation display.

Depending on the operation mode, the operation display shows the corresponding information: In **Figure 43 top**, Push button operation mode. In **Figure 43 bottom**, External operation mode).

The **footer left** always displays the current time.

When the timer is activated, the **footer centre/right** (e.g., Thu 10:45 am) shows the next switch time.

The header contains additional symbols for current operation settings.

Symbol	Description
	Level in fog maker container not reached, fog maker container empty
	Level in fog maker container reached, fog maker container full
	Push button operation mode is selected (if the symbol is absent, the operation mode is not selected)
	Push button operation mode is active.
	Timer is selected and in standby position (if the symbol is absent, the timer is not selected)
	Timer is selected and ready for operation (if the symbol is absent, the timer is not selected)
	Operating contact open (system/device in standby position)
	Operating contact closed (system/device ready for operation)

8.7.2 Start disinfection

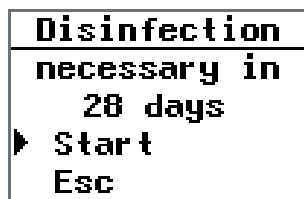



Fig. 44: Menu: Disinfection

- 1) Select the **Disinfection** entry in the main menu and confirm with the Enter key .

The Disinfection menu shows the days after which the next disinfection is necessary at the latest.

- 2) Select **start** using the operating buttons, start with the Enter key  and follow the programme guide. Now the disinfection can only be cancelled by switching off at the main switch.

Notice: If the Disinfection menu is exited with **Esc**, the display returns to the main menu.

Further information on carrying out a disinfection can be found in *Chapter 7.8 on page 27*.

8.7.3 Set pause time

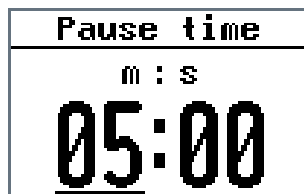





Fig. 45: Menu: Pause time

The pause time denotes the time between 2 fogging times.

- 1) Select the **Pause time** entry in the main menu and confirm with the Enter key .
- 2) First set the minutes using the arrow keys, confirm the entry with the Enter key , then set the seconds and save with the Enter key .

The display returns to the main menu.

8.7.4 Set fogging time

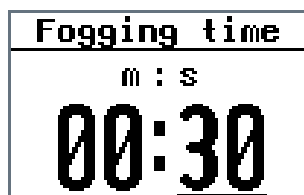





Fig. 46: Menu: Fogging time

The fogging time is the time during which the fog is generated.

- 1) Select the **Fogging time** entry in the main menu and confirm with the Enter key .
- 2) First set the minutes using the arrow keys, confirm the entry with the Enter key , then set the seconds and save with the Enter key .

The display returns to the main menu.

8.7.5 Set operation modes

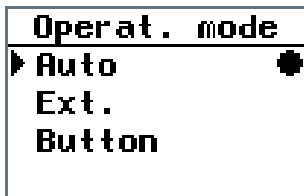



Fig. 47: Menu: Operation mode

- 1) Select the **Operation mode** entry in the main menu and confirm with the Enter key .
- 2) Select the operation mode using the arrow keys and save with the Enter key .

The display returns to the main menu.

The 3 operation modes

Requirement for all operation modes:

- The operating contact must be closed.
- The switch times must be set on the week days if the timer is activated.

- **Auto:** Once switched on, the device works with the internal settings (fogging time, pause time, timer).
- **Externally:** The device can be activated (fog on) or deactivated (standby position) via an external contact (e.g., higher-level control such as WDT central control). As long as the contact is closed, fog is generated.

The dosing time and pause time can be specified with a higher-level control

The external contact is **not active** when the operation mode **Auto** or **Push button** has been selected.

- **Push button:** In push-button operation, the fogging is started via the push-button (option) in the cabin and operated for the set push-button cycle time, with the settings of the pause and fogging time.

8.7.6 Set push button cycle

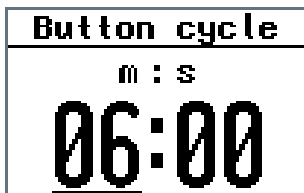





Fig. 48: Menu: Push button cycle

The push button cycle is the period during which the set fogging and pause times run in a repeated cycle until the time period has expired (Fig. 49). The time period (push button cycle) can only be set in the Push button operation mode. The push button cycle can only be started by pressing the push button.

- 1) Select the **Push button cycle** entry in the main menu and confirm with the Enter key .
- 2) First set the minutes using the arrow keys, confirm the entry with the Enter key , then set the seconds and save with the Enter key .

The display returns to the main menu.

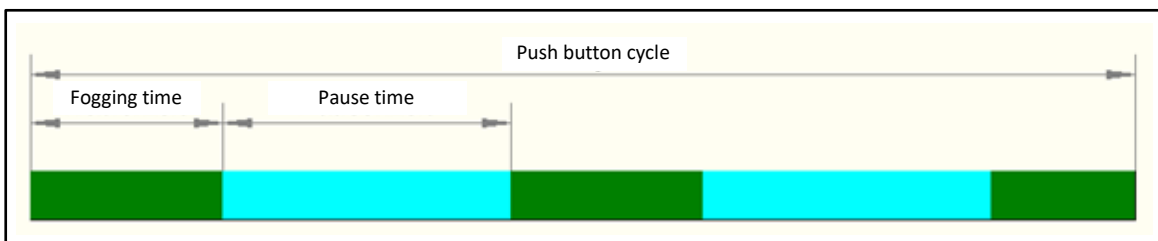

Fig. 49: Illustration push button cycle

8.7.7 Set fan rotation speed

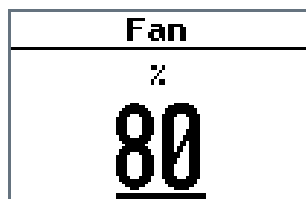



Fig. 50: Menu: Fan

The fan rotation speed (in percent) determines the strength of the air flow with which the vaporised brine is supplied to the cabin.

- 1) Select the **Fan** entry in the main menu and confirm with the Enter key .
- 2) Use the arrow keys to select the speed in percent and save with the Enter key .

The display returns to the main menu.



NOTICE

During a disinfection, the fan always runs at full performance.

8.7.8 Check electrical outputs



NOTICE

The control unit does **not** switch automatically from the test menu to the main menu. The test menu must actively be terminated with **Esc** to return to the main menu.

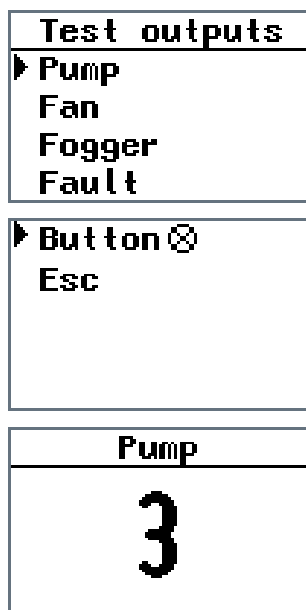





Fig. 51: Menu: Test outputs

You can test the different electrical outputs in this sub-menu.

- 1) Select the **Test outputs** entry in the main menu and confirm with the Enter key .
- 2) Select the desired component using the arrow keys and confirm with the Enter key .
- 3) The display counts down the respective remaining control time (sample display: pump with 3 seconds remaining time):
 - **Pump**: 5 seconds
 - **Fan**: 20 seconds
 - **Fogger**: 20 seconds
 - **(Collective) Fault**: 20 seconds
 - **Button**: 20 seconds

The test can be cancelled at any time using the Enter key .

Once the respective test has been completed, the display switches back to the overview of the outputs.

- 4) In the overview, select the **Esc** entry to navigate to the main menu.

8.7.9 Check electrical inputs

Test inputs	
Level	●
Button	○
Ext.	○
op. contact	●

Fig. 52: Menu: Test inputs

You can test the different electrical inputs in this submenu.

- 1) Select the **Test inputs** entry in the main menu and confirm with the Enter key .

The inputs are marked with a red circle on the right side:

- Filled circle: Input active
- Empty circle: Input inactive

Depending on the connection and equipment, the push-button or the operating contact, for example, may not be triggered.

- 2) Press the Enter key  to exit the menu.



NOTICE

The control unit does **not** switch automatically from the test menu to the main menu. The test menu must actively be terminated with **Esc** to return to the main menu.

8.7.10 Set language

Language	
Deutsch	
▶ English	●
Français	

Fig. 53: Menu: Language

You can select the display language in this submenu

- 1) Select the **Language** entry in the main menu and confirm with the Enter key .

The set language is marked with a circle on the right side.

- 2) Select the language using the arrow keys and save with the Enter key .

The display returns to the main menu.

8.7.11 Set Time/date

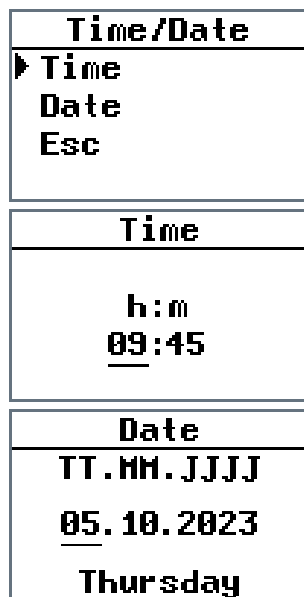

Fig. 54: Menu: Time/date

You can set the time and date in this submenu.

- 1) Select the **Time/Date** entry in the main menu and confirm with the Enter key .
- 2) Select the **Time** or **Date** entry using the arrow keys and confirm with the Enter key .

The entry to be changed (hour, minute, day, month, year) is marked with an underscore.

- 3) Use the arrow keys to set the value and confirm the entry with the Enter key .

The display automatically jumps to the next value.

- 4) Once the last possible entry has been confirmed, the display switches back to the selection of **Time** or **Date**.
- 5) In the overview, select the **Esc** entry to navigate to the main menu.

8.7.12 Time switch / set switch times

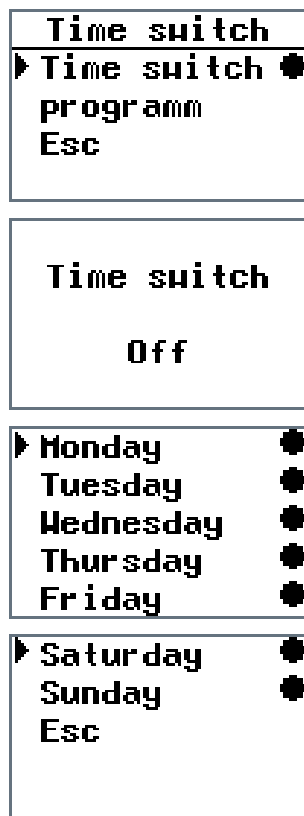

Fig. 55: Menu: Timer weekly overview

The timer function can be switched on and off with the Enter key in the **Time switch** submenu. If the timer is activated, a black dot appears on the right side. Fog can then only be produced during the set switch times in all operation modes.

Days and time periods during which it is possible to start the brine fog maker can be set in the **Timer/programm** submenu. Per day, 1 time window (**On** – **Off**) can be entered. The switch times apply to all operation modes.

- 1) Select the **Time switch** entry in the main menu and confirm with the Enter key .

The week days are marked with a circle on the right side:

- Filled circle: A time has been set.
- Empty circle: **No** time has been set.

- 2) Use the arrow keys to select the week day and confirm with the Enter key .

Monday	
	h:m
On	<u>07:00</u>
Off	17:00
Tuesday	
	h:m
On	<u>--:--</u>
Off	--:--

Fig. 56: Menu: Timer switch, switch times

The entry to be changed (On: Hour/minute, Off: hour/minute) is marked with an underscore.

- Use the arrow keys to set the value and confirm the entry with the Enter key .

The display automatically jumps to the next value.

- Once the last possible entry has been confirmed, the display switches back to the selection of the week day. Use Esc to navigate to the higher-level Timer menu.
- Select the Timer entry menu and confirm with the Enter key  to activate or deactivate the timer function for all days.
- In the overview, select the **Esc** entry to navigate to the Timer submenu. All saved times are retained in this case, even when the timer is deactivated!
- In the overview, select the **Esc** entry to navigate to the main menu.



NOTICE

The newly set times are only saved if they are confirmed with the Enter key. Per day, 1 time period (On – Off) can be entered.

Without input, the control unit **automatically** switches from the **Timer** menu to the main menu after 30 seconds. **In this case, the settings made are not saved.** The menu can actively be terminated with **Esc** to return to the main menu.

If the device is intended to be available all day, set the switch-on time to **12:01 am** and the switch-off time to **11:59 pm**.





Fig. 57: Menu: wrong time entry

If an incorrect time is entered, a corresponding warning notice appears in the display and the entry is deleted!



NOTICE

You can tell if the timer function is activated by the corresponding symbol shown in the operation display.

Symbol	Description
	Timer is selected and inactive. The time at which operation is released and the brine fog maker can be started is shown in the display at the bottom right. (If the symbol is absent in the operation display, the timer function is switched off.)
	Timer is selected and active. The time at which operation is terminated and the brine fog maker can no longer be started after this time is shown in the display at the bottom right. (If the symbol is absent in the operation display, the timer function is switched off.)

8.7.13 Set contrast

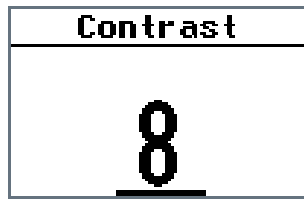



Fig. 58: Menu: Contrast

You can set the contrast of the display in this submenu.

- 1) Select the **Contrast** entry in the main menu and confirm with the Enter key .
- 2) Use the arrow keys to set the value and confirm the entry with the Enter key .

The display returns to the main menu.

8.7.14 Display device information

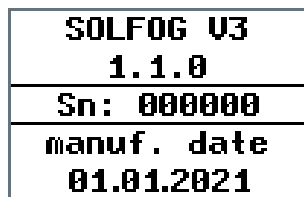



Fig. 59: Menu: Info

You can display the device information in this submenu.

- 1) Select the **Info** entry in the main menu and confirm with the Enter key .

The display shows the device type, software version, serial number and date of manufacturing.

- 2) Use the Enter key  to return to the main menu.



NOTICE

Have this information available for any support queries!

8.7.15 Display data log

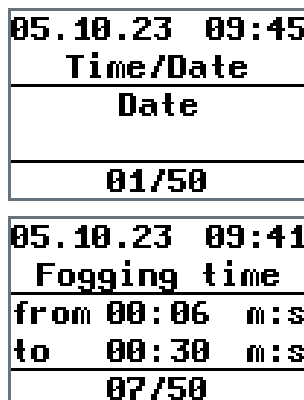



Fig. 60: Menu: Data log

The device saves the last 50 changes or faults. You can display this information in this submenu.

- 1) Select the **Data log** entry in the main menu and confirm with the Enter key .
- 2) Use the arrow keys to look at the individual entries.
- 3) Use the Enter key  to return to the main menu.

If a memory card is inserted, all changes are written to the memory card.

8.7.16 Conduct a reset

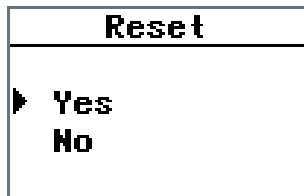

Fig. 61: Menu: Reset

In this submenu, you can reset the device to the ex works settings.

Afterwards, the device behaves as it did when it was switched on for the first time. The start query occurs as described in Chapter 7.7 on page. 26.

- 1) Select the **Data log** entry in the main menu and confirm with the Enter key .
- 2) Enter the password **0123** in the password dialogue and confirm it with the Enter key .
- 3) Select the **Yes** entry using the arrow keys and confirm the entry with the Enter key .



NOTICE

After the reset, the device starts with the start query, and the setting values (including the timer) are reset to the ex works settings. The values must be reentered.

8.7.17 Config / set password protection

In the Config menu, password protection can be activated and configurations can be set for the push button illumination.



Fig. 62: Menu: Config - Password

The **Config** menu can be found at the very bottom of the main menu. In the **Config** submenu, settings can be protected against being changed with the user password.

This may be necessary if the device is placed in a freely accessible area and needs to be protected from unauthorised operation.

If password protection is activated, all password-protected menus are marked with a padlock symbol in the main menu. The menus cannot be protected individually.

The Config and Reset menus are always password-protected!

- 1) Select the **Config** entry in the main menu and confirm with the Enter key .
- 2) Enter the password **0123** in the password dialogue and confirm it with the Enter key .
- 3) Use the arrow keys to select the corresponding parameter entry and confirm the entry with the Enter key .
- 4) Confirm the selection:
 - a) Select **Yes** to change the settings and navigate back to the main menu
 - b) Select **No** to navigate back to the main menu without changes

8.7.18 Set Config / Push button illumination

The Config menu is always password-protected. The push button illumination can be configured individually here.

```

password
▶ button +-
  button Dim.
  Fan
  Esc
    
```

```

  button +-
▶ Button +
  Esc
    
```

```

  button Dim.
▶ active ⊗
  pause ⊗
  Esc
    
```

```

  Fan
  permanent run
▶ On
  Off
    
```

Fig. 63: Menu: Config - Password

Button +- (push button polarity):

The polarity, i.e., plus side and minus side, of the push button illumination is **inverted** here. The function is important when using external push buttons. If you have any questions, please contact your service partner.

- 1) Switch to the `button +-` submenu.
- 2) Select the desired polarity for the push button. Ex works setting is `button -`; with the `button +` setting, the button illumination and the fog lighting are **inverted**. (see wiring diagram) Dimming of the fog lighting is not provided.

Settings example:

`button - / operation / 15` → Push button illumination for operation at maximum intensity

`button + / operation / 15` → Push button illumination for operation is off.

button dim:

There is a different setting for the push button illumination between operation of the device and during the pause time.

Switch to the `button dim` submenu

The push button dimming is used to set the push button illumination.

The intensity of the push button illumination during operation and during the pause time is set here.

Fan permanent run

The fan can be set to permanent run here. This means that the fan is running even when no fog is produced. Permanent operation may be necessary if there is overpressure in the cabin, which could cause the salt fog to be forced back into the SOLFOG.



NOTICE

The **Reset** and **Config** parameter entries are always protected by the user password. The password protection cannot be deactivated here.

8.8 Change the brine solution



WARNING!

Health hazard due to germ contamination!

Over-aged brine solution can lead to the formation of germs, which can enter the application room via the fogging and be inhaled there!

- When stocking the necessary consumables, pay attention to shelf life, storage time and storability!
- Check the use-by date before using a new brine solution!
- After opening, the brine has a maximum shelf life of 28 days! After that, the brine must be disposed of with the politainer!

For information on changing the brine politainer, please pay attention to Chapter 0 on page 33.

8.9 Replenish fragrance oil concentrate



WARNING!

Danger of irritation or and allergic reactions!



Undiluted fragrance oil concentrates may cause irritation and allergic reactions.

- Do not allow to come into contact with skin or eyes!
- Wear chemical-resistant protective gloves and goggles!



WARNING!

Ignition hazard!

Undiluted fragrance oil concentrates may be highly flammable!

- Pay attention to the rules for handling flammable liquids!
- Avoid ignition sources (e.g., hot surfaces, sparking, open fire or cigarettes)!

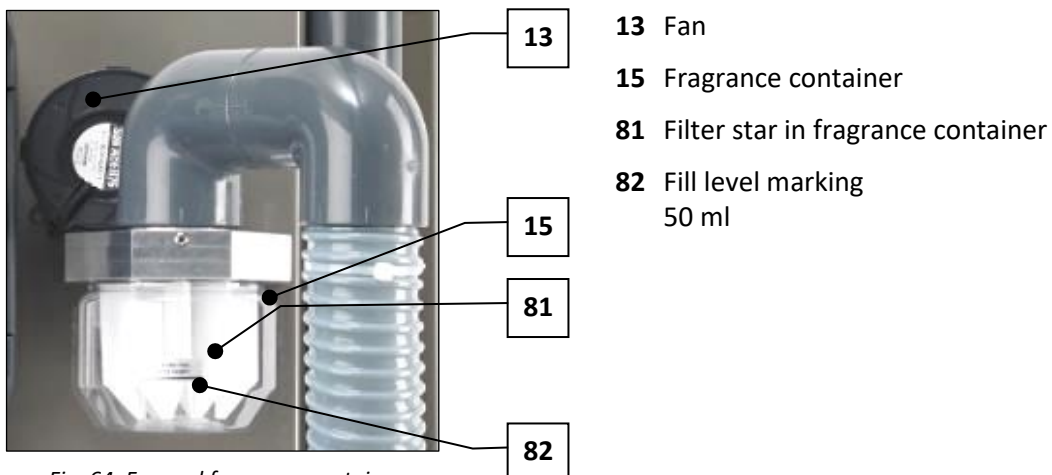

Fig. 64: Fan and fragrance container

To replenish the fragrance oil concentrate, proceed as follows:

- 1) Deactivate the device at the *main switch* (Fig. 38, No. 03).



WARNING!

Risk of injury when carrying out filling work during ongoing operation!

- Always switch off the device before refilling consumables!
 - Never open locks and lines during ongoing operation!
 - Always switch off the device prior to working on containers or lines!
- 2) Unscrew the *fragrance container* (Fig. 64, No. 15) from the aluminium holder and clean it, if necessary, or use a new fragrance container.
 - 3) Insert a clean *filter star* (Fig. 64, No. 81) in the fragrance container.
Fill the desired fragrance concentrate into the fragrance container up to the *fill level marking* (Fig. 64, No. 82) (max. 50 ml).



ATTENTION!

Restricted operation or damage due to unsuitable fragrance oil concentrates!

Unsuitable fragrance oil concentrates that are not certified and approved by WDT may restrict the operation of the device or damage it!

- Only use WDT fragrance oil concentrates for room scenting!
- 4) Screw the *fragrance container* (Fig. 64, No. 15) back into the aluminium holder and check for a tight fit.
 - 5) Activate the device at the *main switch* (Fig. 38, No. 03).

9 Maintenance / Fault removal

9.1 Open/close the control housing

During fault removal, it may be necessary to open the control housing.



WARNING!

Danger of electric shock!

Dangerous electrical voltage!

- All work on the device must be carried out by specialist personnel only!
- All electrical installations and any work on the device's electrical components must be carried out by authorised electricians only!
- Prior to starting work, disconnect the devices from the power supply and secure them against being reactivated!
- After corresponding electrical installation or repair, test all protective measures used (e.g., earthing resistance)!



ATTENTION!

Danger due to static charge!

This safety notice denotes electronic components that may be damaged by electrostatic discharges.

The generally accepted safety precautions for ESD-sensitive devices must be observed when handling the devices!

In particular, the following applies for work on the control board:

- Only unplug or plug in connectors when they are disconnected from the power supply!
- As the person handling the device, please discharge yourself electrostatically for at least 5 seconds prior to directly touching the devices, e.g., by touching a grounded part of the system or by wearing an ESD antistatic wrist strap connected to ground!

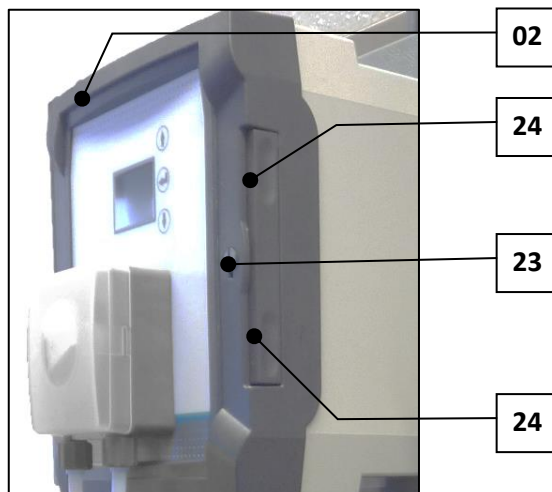

- 1) Unlock the *locking knob* (Fig. 65, No. 23) with a screwdriver.
- 2) Press down on both *recessed grips* (Fig. 65, No. 24) until the housing snaps open.
- 3) Rotate the cover to the side.

Close the housing in reverse sequence.

Fig. 65: Open control housing

9.2 Device maintenance



NOTICE

We recommend that you assign a specialist firm to carry out regular maintenance.

In order to ensure the proper function of the SOLFOG V3, pay attention to the following points:

- Disinfection and maintenance in accordance with the maintenance protocol in Chapter 11.5 on page 63.
- Stocking of the required consumables. Pay attention to shelf life and storage time!



WARNING!

Health hazard due to germ contamination!

Over-aged brine solution can lead to the formation of germs, which can enter the application room via the fogging and be inhaled there!

- **When stocking the necessary consumables, pay attention to shelf life, storage time and storability!**
- **Check the use-by date before using a new brine solution!**
- **After opening, the brine has a maximum shelf life of 28 days! After that, the brine must be disposed of with the politainer!**
- **A disinfection must be carried out during each politainer change, or at least every 28 days!**



ATTENTION!

Brine water leaves stains and corrodes metal!

- **Remove moist sole stains from the device!**
- **Regularly clean the device!**

9.3 Check/change hose bracket kit

The pump hose in the pump is subject to mechanical and chemical stresses.

Therefore, the pump hose must be checked once a month in order to detect damage (e.g., cracks, discolouration) in due time and to replace the dosing hose.

The dosing hose must be replaced **at least every 6 months!**

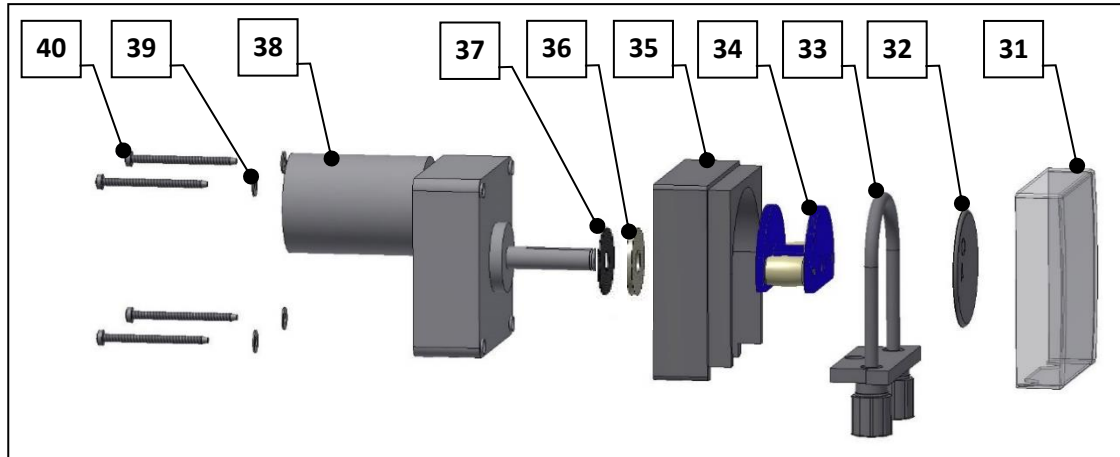

Fig. 66: Individual components of the peristaltic pump

- | | | | |
|----|-------------------------------|----|---------------------|
| 31 | Transparent protective cover | 32 | Safety disc |
| 33 | Hose bracket with dosing hose | 34 | Roller carrier |
| 35 | Pump casing | 36 | Sealing washer felt |
| 37 | Sealing washer EPDM | 38 | Gear motor |
| 39 | Flat washer | 40 | Screw |

9.3.1 Replace hose bracket kit and roller carrier

See description in *Chapter 7.5 on page 24*.

9.3.2 Renew hose on hose bracket



WARNING!

Risk of crushing!



Injury to fingers (crushing) possible!

- Only conduct the work when the device has been switched off and secured against being reactivated!



ATTENTION!

Risk of damage due to an unsuitable hose!

- The new hose must match the disassembled hose in colour and size!
- The hose must not be twisted when inserted!
- The markings on the hose ends must be visible in the front and centre (see Fig. 67)!

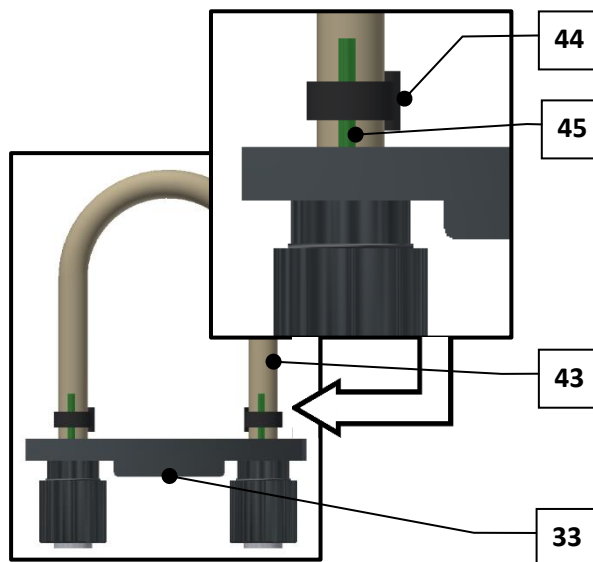

Fig. 67: Hose bracket kit, marking

- 1) Disassemble hose bracket kit (see Chapter 7.5 on page 24).
- 2) To replace the dosing hose (Fig. 67, No. 43) at the hose bracket (Fig. 67, No. 33), **carefully** cut the hose clamps (Fig. 67, No. 44) with a sharp knife or a pair of pliers!

Make sure you do not damage the hose nipples of the hose bracket in the process!

- 3) Push the new dosing hose onto the hose nipples so that the markings on the hose ends are visible in the front and centre! (Fig. 67, No. 45) This ensures that the hose is not twisted.
- 4) Fix the hose ends with new hose clamps and cut off the protruding ends of the hose clamp.
- 5) Install the hose bracket kit (see Chapter 7.5 on page 24).

9.4 Cleaning of the fog maker container



ATTENTION!

Damage to the fog maker diaphragm!

- Do not clean the fog maker diaphragm with pointy or sharp objects!
- Only use 1% citric acid for cleaning
- Only use a soft cloth or paper towel for cleaning!



NOTICE

For the fog maker container's maintenance interval, see maintenance protocol in Chapter 11.5 on page 63.

9.5 Faults

9.5.1 General safety notices



WARNING!

Danger of electric shock!

Dangerous electrical voltage!

- All work on the device must be carried out by specialist personnel only!
- All electrical installations and any work on the device's electrical components must be carried out by authorised electricians only!
- Prior to starting work, disconnect the devices from the power supply and secure them against being reactivated!



WARNING!

Danger of irritation and/or allergic reactions!

Undiluted fragrance oil concentrates may cause irritation and allergic reactions!



- Do not drink, smoke or rub in!
- Use fragrance oil concentrates only for room scenting with the SOLFOG!
- Keep out of the reach of children!
- Do not allow to come into contact with skin or eyes!
- Wear chemical-resistant protective gloves and goggles!



WARNING!

Risk of crushing!

Injury to fingers (crushing) possible!



- Wear thin gloves when engaged in fault removal!

9.5.2 Fault indications





The following fault indications can be displayed on the device.

For the removal of fault indications, see the following fault table.

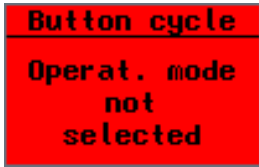

NOTICE

During a fault in the device, the fogging is interrupted.

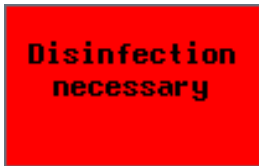
Fault indication	Cause / effect	Action
 Politainer empty	<ul style="list-style-type: none"> • Brine politainer empty • Peristaltic pump does not work • Level control plug unplugged/defective 	<ul style="list-style-type: none"> • Renew politainer • Check peristaltic pump • Check level control plug
 Filling time has expired	<ul style="list-style-type: none"> • Brine politainer empty • Peristaltic pump does not work • Level control plug unplugged/defective 	<ul style="list-style-type: none"> • Renew politainer • Check peristaltic pump • Check level control plug
 Button cycle; Operation mode not selected	<ul style="list-style-type: none"> • Incorrect operation mode set 	<ul style="list-style-type: none"> • Use the Enter key to return to the main menu Notice: This setting is only relevant in the Push button operation mode
 wrong time entry	<ul style="list-style-type: none"> • An unrecognisable time was entered 	<ul style="list-style-type: none"> • Enter correct time
 Incorrect Password	<ul style="list-style-type: none"> • Incorrect password entry 	<ul style="list-style-type: none"> • Enter correct password
 Disinfection necessary	<ul style="list-style-type: none"> • Maximum runtime of 28 days has expired 	<ul style="list-style-type: none"> • Carry out disinfection, as described in Chapter 7.8 on page 27

9.5.3 Fault removal

Fault	Cause / effect	Action
The device cannot be switched on	<ul style="list-style-type: none"> • Main fuse defective • Main switch defective • Power supply interrupted 	<ul style="list-style-type: none"> • Check/renew fuse • Check main switch • Check power supply
Device without function	<ul style="list-style-type: none"> • incorrect setting • Main fuse defective • Control board defective • Power plug unplugged • Operating contact open 	<ul style="list-style-type: none"> • Check/reset settings • Renew fuse • Check/renew circuit board • Check power plug • Close operating contact
Peristaltic pump without function	<ul style="list-style-type: none"> • Fuse defective • Pump motor defective 	<ul style="list-style-type: none"> • Renew fuse • Check/renew pump motor
Push button illumination without function	<ul style="list-style-type: none"> • Fuse defective • Push button incorrectly connected electrically • Incorrect setting on the push button illumination 	<ul style="list-style-type: none"> • Renew fuse • Check electrical connection • Correct settings in the Config menu
No discernible scent	<ul style="list-style-type: none"> • Fragrance container empty/dried up • Fuse defective • Fan defective • incorrect fragrance 	<ul style="list-style-type: none"> • Check/replenish fragrance oil concentrate • Check/renew fuse • Renew fan • use suitable fragrance
No fog production	<ul style="list-style-type: none"> • Fog maker container empty • Ultrasonic fog maker defective or unplugged • Fan defective • Transformer for ultrasonic fog maker defective • Diaphragm dirty • Fog maker container over-filled 	<ul style="list-style-type: none"> • Check line for leaks • Renew ultrasonic fog maker; check ultrasonic fog maker plug • Check/renew fan • Renew transformer • Clean diaphragm • Correct filling volume
Fog lighting without light	<ul style="list-style-type: none"> • No fog production • Cable not plugged in • Lighting rod defective • Circuit board output defective 	<ul style="list-style-type: none"> • Check the SOLFOG's fog production (the light is only illuminated when the fog production is running) • Check cable and coupling • Renew the lighting rod • Check outlet/renew circuit board

10 Decommissioning / Storage / Disposal

10.1 Decommissioning



WARNING!

Ignition hazard!

Undiluted fragrance oil concentrates may be highly flammable!

- Pay attention to the rules for handling flammable liquids!
- Avoid ignition sources (e.g., hot surfaces, sparking, open fire or cigarettes)!



WARNING!

Risk of crushing!



Injury to fingers (crushing) possible!

- Wear thin gloves when engaged in fault removal!

Pay attention to the following notices when decommissioning the device:

- For decommissioning of a maximum of 28 day, deactivate the device at the main switch.
- For decommissioning of more than 7 days, the fog maker container must be manually emptied and cleaned.
Clean and dry the fog maker head with a soft cloth (microfibre cloth).
Remove and dispose of the brine politainer.
- Remove the brine pump's roller carriers to avoid any damage to the dosing hose (see Chapter 7.5 on page 24).
- Prior to an extended decommissioning, rinse the device with distilled water to prevent encrustations. Empty and dry the fog maker container. Empty and clean the fragrance container.

10.2 Storage

Pay attention to the following notices when storing the device:

- After decommissioning, store the device in a dry location protected from frost!
- Pay attention to the notices in *Chapter 3.4.6* on page 15!

10.3 Recommissioning



ATTENTION!

Damage due to incorrect commissioning!

- Observe the sequence of the commissioning steps!
- Pay attention to the information in the commissioning protocol according to *Chapter 11.3* on page 62!

When recommissioning the device, follow the commissioning steps according to Chapter 7 on page 23 and pay attention to the points in the commissioning protocol according to Chapter 0 on page 62!

10.4 Disposal



WARNING!

Danger of environmental damage!



Undiluted fragrance oil concentrates are toxic to aquatic organisms, with long-term effects.

- Pay attention to the disposal regulations!
- Also pay attention to the safety data sheet!



ATTENTION!

Environmental damage due to improper disposal!



- Pay attention to the national and local laws, ordinances and regulations regarding the disposal of mechanical and electronic components!

Pay attention to the following notices when disposing of the device:

- Thoroughly clean any dismantled parts prior to disposal.
- Used parts and operating materials must be disposed of according to the regulations applicable at the site of operation, or they must be recycled.
- If operating materials are subject to special regulations, please pay attention to the corresponding information on the packaging.
- When in doubt, information may be obtained from the institution responsible for disposal at your location.

11 Documents

11.1 Declaration of conformity

<p>WDT Werner Dosiertechnik GmbH & Co. KG Hettlinger Straße 17 D-86637 Wertingen Tel. 0049 8272 98697-0 Fax 0049 8272 98697-19 info@werner-dosiertechnik.de www.werner-dosiertechnik.de</p>							
<p>EG-Konformitätserklärung EC declaration of conformity Déclaration de conformité UE</p> <p>im Sinne der EG-Maschinenrichtlinie 2006/42/EG, Anhang II 1.A as defined in the EC Machinery Directive 2006/42 / EC, Annex II, Part 1A selon la directive européenne machines 2006/42 / CE, annexe II 1.A</p>							
<p>Hersteller WDT - Werner Dosiertechnik GmbH & Co. KG Manufacturer Hettlinger Str. 17 Fabricant 86637 Wertingen-Geratschhofen</p>							
<p>Beschreibung und Identifikation des Produktes: Description and identification of the product: Description et identification du produit :</p>							
<table border="1"> <tr> <td>Typenbezeichnung:</td> <td>Art:</td> </tr> <tr> <td> <ul style="list-style-type: none"> Solevernebelungsgerät Solfog V2 Solevernebelungsgerät Solfog V3 </td> <td>Maschine</td> </tr> </table>		Typenbezeichnung:	Art:	<ul style="list-style-type: none"> Solevernebelungsgerät Solfog V2 Solevernebelungsgerät Solfog V3 	Maschine		
Typenbezeichnung:	Art:						
<ul style="list-style-type: none"> Solevernebelungsgerät Solfog V2 Solevernebelungsgerät Solfog V3 	Maschine						
<p>Funktion: Solevernebelungssystem für den Wellness-Bereich Function: Nebulization of brine solution for the wellness area Fonction: Système de nébulisation unique pour l'espace bien-être</p>							
<p>Es wird ausdrücklich erklärt, dass das Produkt allen einschlägigen Bestimmungen der folgenden EG-Richtlinien entspricht: It is expressly stated that the product complies with all relevant provisions of the following EC directives Il est explicitement dit que le produit est conforme à toutes les dispositions pertinentes des directives CE suivantes :</p>							
<p>2006/42/EG RICHTLINIE 2006/42/EG DES EUROPÄISCHEN PARLAMENTS UND DES RATES vom 17. Mai 2006 über Maschinen und zur Änderung der Richtlinie 95/16/EG (Neufassung)</p>							
<p>Die folgenden harmonisierten Normen nach Artikel 7 (2) wurden angewandt: The following harmonized standards as defined in Article 7 (2) were applied: Les normes harmonisées suivantes selon l'article 7 (2) ont été appliquées :</p>							
<p>EN ISO 12100:2010 Sicherheit von Maschinen - Allgemeine Gestaltungsleitsätze - Risikobeurteilung und Risikominderung EN ISO 13849-1:2015 Sicherheit von Maschinen – Sicherheitsbezogene Teile von Steuerungen – Teil 1: Allgemeine Gestaltungsleitsätze EN ISO 13849-2:2012 Sicherheit von Maschinen – Sicherheitsbezogene Teile von Steuerungen – Teil 2: Validierung EN 60204-1:2018 Sicherheit von Maschinen – Elektrische Ausrüstung von Maschinen – Teil 1: Allgemeine Anforderungen</p>							
<p>Die in der Gemeinschaft ansässige Person, die für die Zusammenstellung der technischen Unterlagen bevollmächtigt ist: The designated person who is authorized to draw up the technical documentation: La personne établie dans la communauté qui est autorisée à constituer le dossier technique:</p>							
<p>Name: Werner Dosiertechnik GmbH & Co KG Straße/Nr.: Hettlinger Straße 17 PLZ Stadt: 86637 Wertingen</p>		 					
<p>Wertingen, 08.12.2022 Ort/City/Place, Datum/Date</p>		<p>Unterschrift/signature Rainer Rieger, Director</p>					
<p>CE DW 009-02 Konformitätserklärung Solfog V2+V3.docx</p>							

11.2 Wiring diagrams

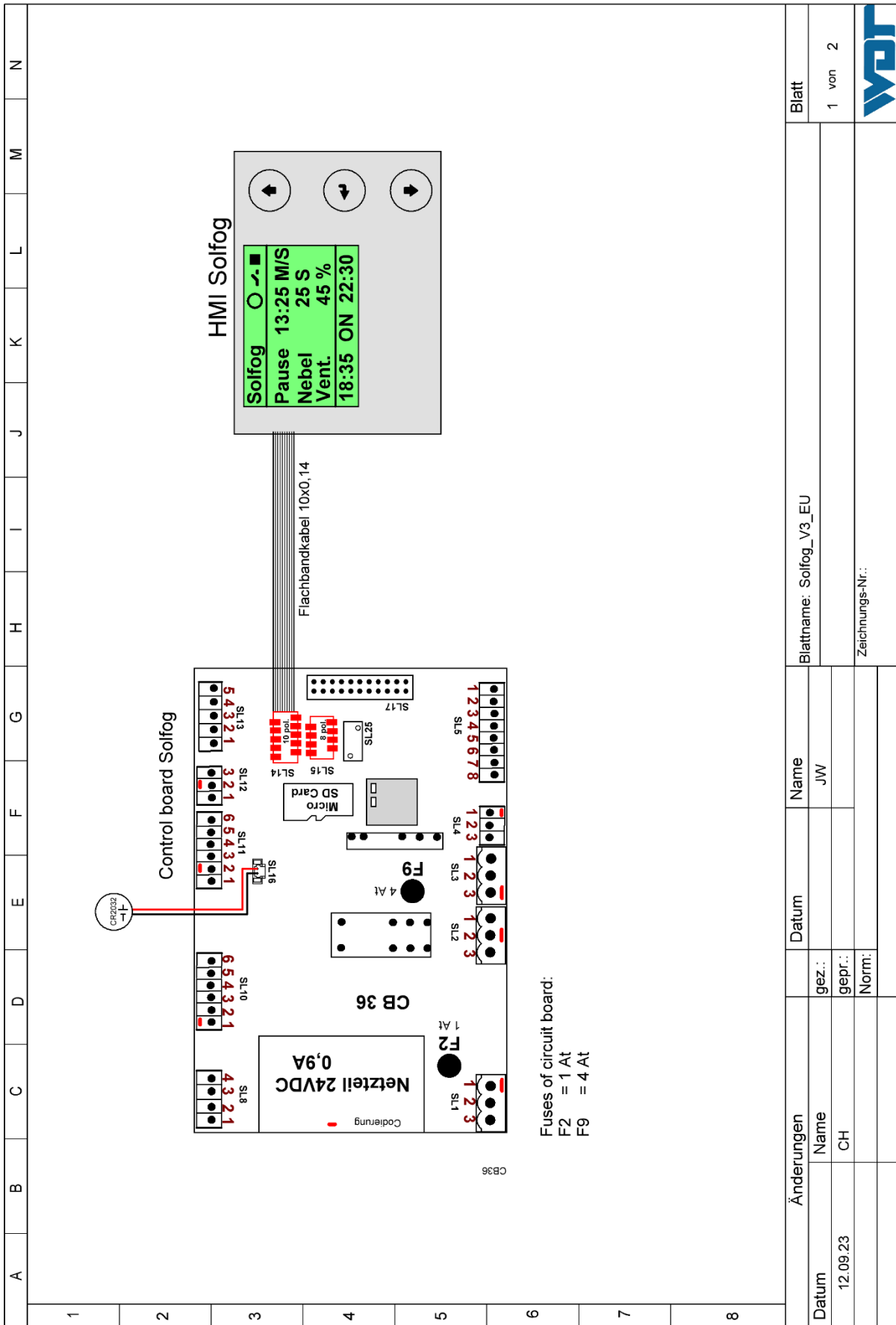

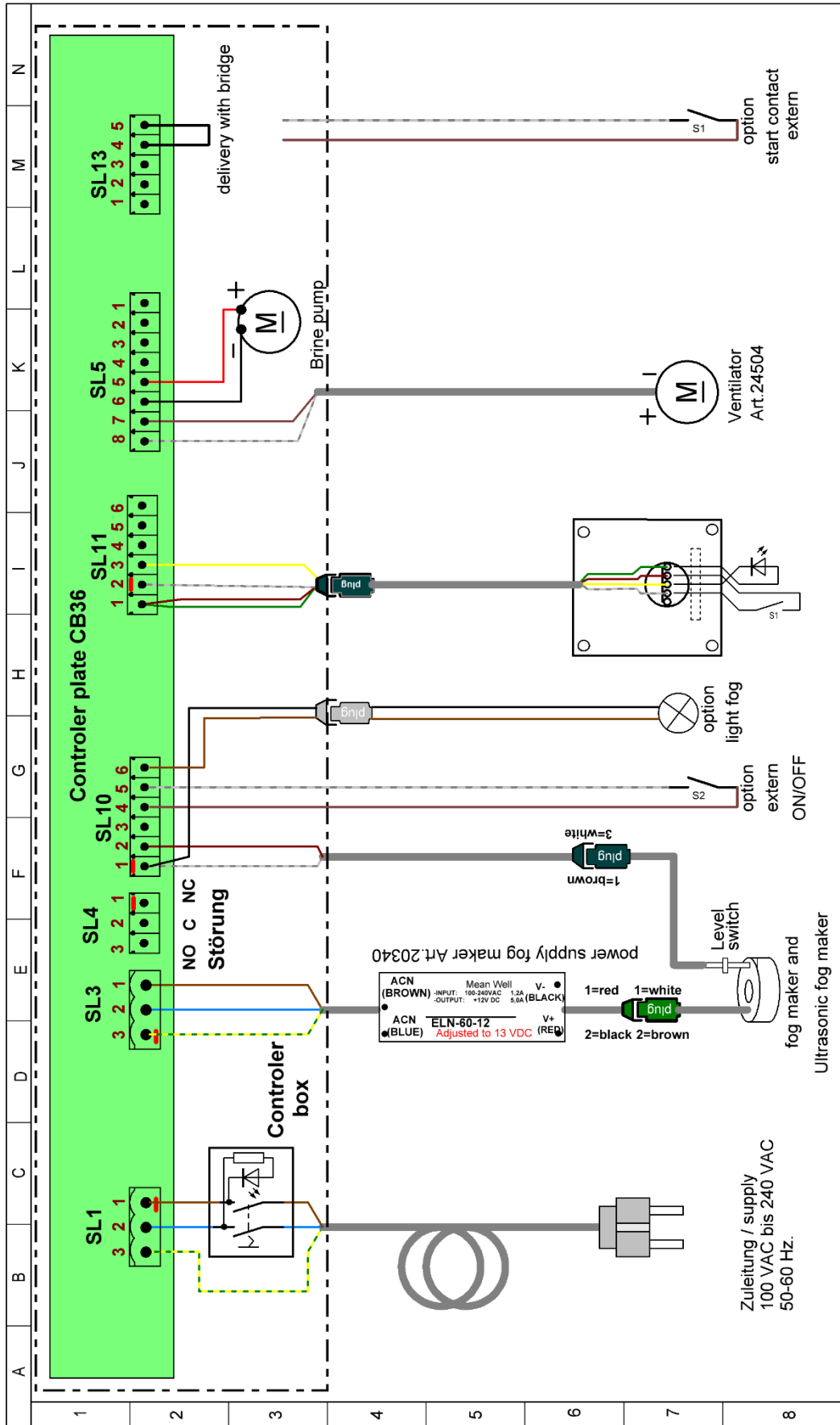

Änderungen		Datum	Name	Blattname: Solfog_V3_EU	page
Datum	Name	gez.:	JW		2 von 2
12.09.23	CH	gepr.:			
		Norm.:		Zeichnungs-Nr.:	

11.3 Commissioning protocol

This protocol is to be completed by the commissioning technician! Without a completed and signed commissioning protocol, all warranty claims become void!

The commissioning protocol can be found in the accompanying documentation in *Chapter 12*, page 64.

11.4 Operation data sheet



NOTICE

During commissioning, enter the operating parameters in the operation data sheet!

Menu	Factory setting	Setting range	Step	During commissioning Date	Optimised during operation Date
Pause time	5 minutes	1-90 minutes	1		
Fogging time	10 seconds	5-120 seconds	1		
Button cycle	30 minutes	1-60 minutes			
Operation mode	Cyclic	Cyclic Externally Push button			
Fan	60%	60-100%	1		
Contrast	8	0-15	1		
Push button illumination	„~“	+ and -			
Timer		yes no			
Monday		00:01-23:59		_____	_____
Tuesday		00:01-23:59		_____	_____
Wednesday		00:01-23:59		_____	_____
Thursday		00:01-23:59		_____	_____
Friday		00:01-23:59		_____	_____
Saturday		00:01-23:59		_____	_____
Sunday		00:01-23:59		_____	_____

11.7 Spare parts / wear parts / consumables



ATTENTION!

Damage due to unapproved spare parts!

- Only use spare parts approved by the manufacturer!
- Only order spare parts from your service partner or your specialist dealer.

Spare parts list

Device	Item	Designation	Code no. WDT
Peristaltic pump		Cover for pump casing Sa, transparent	14259
		Safety disc for roller carrier Sa grey	13633
		Hose bracket with hose SA-3.2x1.6 Ph	13260
		Gear motor to peristaltic pump Sa	13557
Control unit		Fuse bag 2x1A	24949
		Fuse bag 2x1A	23012
		Housing BCD	27889
		Control board CB36 with plug-VK	29606
		Display HMI, including circuit board	29574
		Mains switch	21468
Fog lighting		Lighting rod with cable	28628
		Complete kit for lighting	28629
		Bracket PVC D 40 for fog maker lighting	28204

Wear parts list

Device	Item	Designation	Code no. WDT
Peristaltic pump		Hose kit A 3.2x1.6-Ph-Sa; 2x	13413
		Roller carrier for peristaltic pump blue	13039

List of consumables

Device	Item	Designation	Code no. WDT
Brine		Brine 5% 1 kg in politainer	17519
		Brine 5% 5 kg in politainer	17613
		Carton brine 5%: 6x1 kg	17669
		Carton brine 5%: 6x5 kg	17667
Disinfection tablets		1 tablet SOLDOS disinfection	19871
		25 tablets SOLDOS disinfection	19871-1

Fragrance oil concentrates

A list of current fragrance oil concentrates can be obtained from your service partner or your specialist dealer.

12 Appendices

- Commissioning Protocol WDT
- Maintenance Protocol WDT
- Installation instructions for flush-mounted box No.: BB DW BB 001-03 Installation flush-mounted box V2

Commissioning Protocol IP-070-EN

Solfog V3



This protocol is to be completed by the commissioning technician! Without a completed and signed commissioning protocol, all warranty claims become void!

Object: _____ Date: __/__/____

City, street, house number: _____

Device type: _____ Year of manufacture: _____ Serial number: _____

	Activity	Completed	Comment
1	<u>Commissioning</u>		
1.1	Device checked for correct installation	<input type="checkbox"/>	
1.2	Device and lines checked for leaks	<input type="checkbox"/>	
1.3	Fog line with a maximum length of 4 m, with gradient toward the brine fog maker	<input type="checkbox"/>	
1.4	Roller carrier inserted according to <i>OI Chapter 7.5</i>	<input type="checkbox"/>	
1.5	Disinfection carried out according to <i>OI Chapter 7.8</i>	<input type="checkbox"/>	
1.6	Brine politainer inserted according to <i>OI Chapter 7.9</i>	<input type="checkbox"/>	
1.7	Settings made, operation mode selected and entered in the operation data sheet under <i>Chapter 11.4</i>	<input type="checkbox"/>	
1.8	All test programmes checked	<input type="checkbox"/>	
1.9	Brine fog maker started	<input type="checkbox"/>	
1.10	Device checked for correct operation	<input type="checkbox"/>	
2	<u>Other</u>		
2.1	Operating instructions reviewed and handed over	<input type="checkbox"/>	
2.2	Service and operating personnel instructed	<input type="checkbox"/>	

Additional remarks:

Commissioning and instruction carried out by: _____

Instructed persons: _____

Signature of commissioner: _____

Countersigned by operator: _____

Maintenance Protocol WP-070-EN

Solfog V3



This protocol is to be completed by the maintenance technician! We reserve the right to determine the warranty conditions when no completed and signed maintenance protocol is available.

Object: _____ Maintenance year: 20____

City, street, house number: _____

Device type: _____ Year of manufacture: _____ Serial number: _____

	Activity	Maintenance interval in months	Month												Comment / additional tasks	
			1	2	3	4	5	6	7	8	9	10	11	12		
1	Brine fog maker															
1.1	Carry out disinfection according to <i>OI Chapter 7.8</i> , at least every 28 days!	X														
1.2	Clean fog maker diaphragm with a soft cloth	1	<input type="checkbox"/>	<input type="checkbox"/>	<input type="checkbox"/>	<input type="checkbox"/>	<input type="checkbox"/>	<input type="checkbox"/>	<input type="checkbox"/>	<input type="checkbox"/>	<input type="checkbox"/>	<input type="checkbox"/>	<input type="checkbox"/>	<input type="checkbox"/>	<input type="checkbox"/>	
1.3	Grease O-ring (on top of the fog maker container)	1	<input type="checkbox"/>	<input type="checkbox"/>	<input type="checkbox"/>	<input type="checkbox"/>	<input type="checkbox"/>	<input type="checkbox"/>	<input type="checkbox"/>	<input type="checkbox"/>	<input type="checkbox"/>	<input type="checkbox"/>	<input type="checkbox"/>	<input type="checkbox"/>	<input type="checkbox"/>	
1.4	Check peristaltic pump for function and leaks	1	<input type="checkbox"/>	<input type="checkbox"/>	<input type="checkbox"/>	<input type="checkbox"/>	<input type="checkbox"/>	<input type="checkbox"/>	<input type="checkbox"/>	<input type="checkbox"/>	<input type="checkbox"/>	<input type="checkbox"/>	<input type="checkbox"/>	<input type="checkbox"/>	<input type="checkbox"/>	
1.5	Check device for leaks and conduct a visual check	3			<input type="checkbox"/>			<input type="checkbox"/>			<input type="checkbox"/>			<input type="checkbox"/>		
1.6	Run test programmes	3			<input type="checkbox"/>			<input type="checkbox"/>			<input type="checkbox"/>			<input type="checkbox"/>		
1.7	Clean device	6						<input type="checkbox"/>						<input type="checkbox"/>		
1.8	Check electric cabling	6						<input type="checkbox"/>						<input type="checkbox"/>		
1.9	Change the hose kit (only use WDT original replacement part)	12												<input type="checkbox"/>		
1.10	Replace filter star, when changing the fragrance	12												<input type="checkbox"/>		
1.11	Replace hose lines	12												<input type="checkbox"/>		

Additional remarks:

Maintenance carried out and device checked for function: _____ Date: _____
Signature

Countersigned by operator: _____

Assembly and sealing of the flush mounted box V2 for push button plates



CAUTION !

Before starting to work, make the electrical lines volt free and protect them against new connection! Wear protective clothes!



1 Assembly in building panels



a) Install the empty conduit at the required place!
Diameter empty conduit type 32 (ID 25mm)
Bend radius min. 10cm

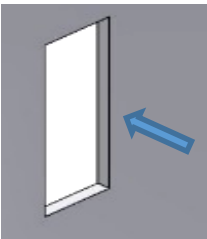

b) Cut out construction plate
 Dimensions:
 1-fold: HxWxD min. 100x67x55mm
 2-fold: HxWxD min. 133x 67x55mm
 3-fold: HxWxD min. 166x 67x55mm
 4-fold: HxWxD min. 200x 67x55mm

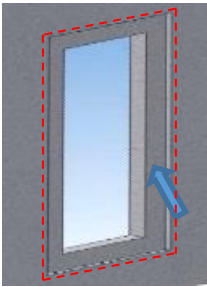

c) Cut a recess to sink the sealing flange with a depth of 3mm
 Dimensions:
 1-fold: HxW min. 130x97mm
 2-fold: HxW min. 163x97mm
 3-fold: HxW min. 196x97mm
 4-fold: HxW min. 229x97mm

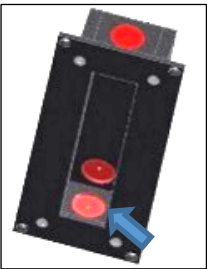

d) Break out an orifice for the empty conduit connection at the desired rated break point

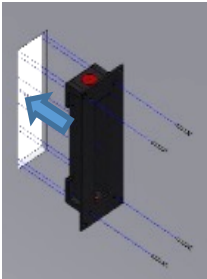

e) Install the flush mounted box and fix with 4 screws if necessary

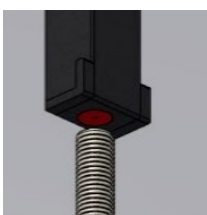

f) Connect the empty conduit onto the flush mounted box and insert cables

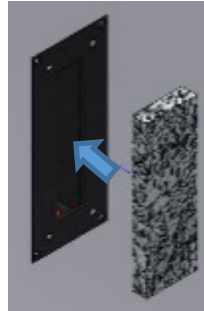

g) Place the supplied construction protection cap in the flush mounted box

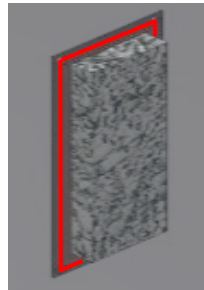

h) Apply sealant for vapour barrier foil



i) Adapt and adhere the vapour barrier foil
No humidity may penetrate!

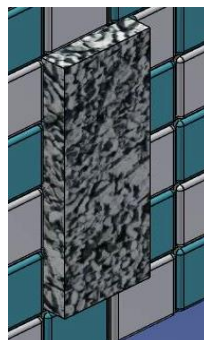

j) Tile the flush mounted box until the construction protection cap

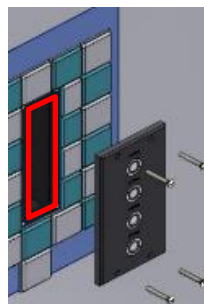

k) Take out the protection cap
 Clamp the push button plate.
Seal the push button plate against the flush mounted box: apply appropriate sealant on the flush mounted box and fix with 4 screws

No humidity may penetrate!

EN - Additional sheet: flush mounted box V2

2 Installation in brickwork

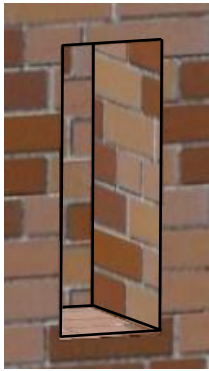

a) Chisel out brickwork for flush mounted box and empty conduit
Diameter empty conduit type 32 (ID 25mm)
Bend radius min. 10cm

Dimensions for break out works
 1-fold: HxWxD min. 105x72x60mm
 2-fold: HxWxD min. 138x72x60mm
 3-fold: HxWxD min. 171x72x60mm
 4-fold: HxWxD min. 205x72x60mm

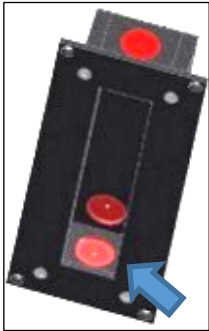

b) Break out an orifice for the empty conduit connection to the desired rated break point

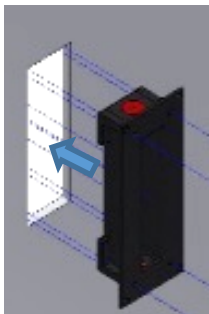

c) Install the flush mounted box and the empty conduit with electrician cast or building foam in the wall, approximately 20 mm protruding due to flush system

Insert cable



d) Install the supplied construction protection cap in the flush mounted box

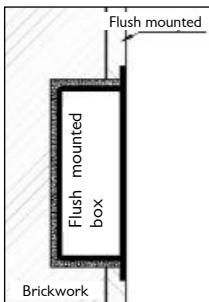

e) Plaster the brickwork so that the flush mounted box flushes with the plaster.

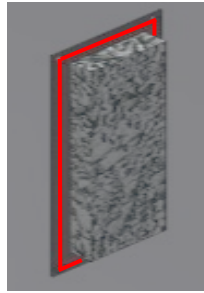

f) Apply sealant for vapour barrier foil



g) Adhere vapour barrier foil
No humidity may penetrate!

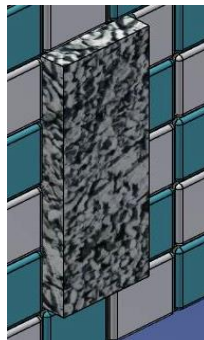

h) Enter the flush mounted box until the construction protection cap

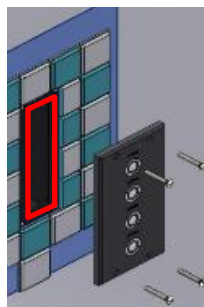

i) Remote protection cap
 Clamp the push button plate.
Seal the push button plate against the flush mounted box: apply appropriate sealant on the flush mounted box and fix with 4 screws

No humidity may penetrate!